

Product Catalogue

Welcome to the latest edition of the **A. N. Wallis Product Catalogue**, which features our complete range of industry leading **Earthing, Exothermic Welding, Surge and Lightning Protection products**.



This year we have increased our already comprehensive range with the addition of a number of new lines, all of which have been specifically developed for the ever changing needs and requirements of our customers. New illustrative images, an updated layout and exceptionally detailed product information tables, make product specifying simple - enabling you to find the right solution, first time.

All A. N. Wallis products are manufactured in Nottingham (U.K.) and are distributed to customers across the world, with many being used on extremely prestigious projects including:

- **The Yas Marina Grand Prix Circuit** in Abu Dhabi
- **Hospitals** in Jordan, Kuwait and Qatar
- **Petrochemical Installations** in Saudi Arabia, Egypt and Oman
- **Mosques** in Bahrain and Kuwait
- **Telecommunication Towers** in Nigeria and Thailand
- **Rail Installations** in Hong Kong and the U.K.
- **Airports** in UAE, Oman and Europe
- The world's largest women's **university** in Riyadh - Saudi Arabia
- **Substations** in Kuwait, Malaysia, Dubai, Abu Dhabi and the U.K.
- **The Presidential Palace** in Abu Dhabi

These are just a few projects that are benefitting from lifelong protection through the use of A. N. Wallis products - why not add your project to the list?

We are constantly striving to provide our customers with the highest quality products, supported by first class customer service. To help us achieve this, we welcome your feedback, comments and suggestions. Please visit our website www.an-wallis.com and register your feedback online.



Welcome to Wallis

Founded over 70 years ago, we have a long tradition of providing first class Earthing, Lightning Protection and Low-Voltage Surge Protection Products.

What's more, we have as broad a range of products as can be found anywhere in the industry.

Wallis also provide a complete range of Technical services, whether you require Lightning Protection Design Services, Earthing Designs, Soil Resistivity Testing, Site Support or Supervision Services we can help you. Contact our office, we are ready to assist you.



All Wallis products are manufactured and tested to British, European and International standards BS EN 62305 and BS 7430. Manufacturing and headquarters are all in Nottingham. UK, with branch offices in Dubai, U.A.E. and Kuala Lumpur, Malaysia. Wallis are accredited with and quality audited to BS EN ISO 9001:2015 and BS OHSAS 18001:2007.

A commitment to excellent customer service also drives what we do. Part of this is ensuring that we maintain good stock levels so you can rely on same-day despatch for many of our products.



Our catalogue continues to evolve - following customer demand we have created a smaller, more portable version without compromising on content. Each edition contains more product information than its predecessor, creating an invaluable resource for all of our customers.

A call for a new design was also heard. Working closely with specialist designers we have produced a catalogue that is not only attractive to look at, but includes all the information you can ever need when specifying A. N. Wallis products.

We know our customers are key to our continued success, so when you talk, we listen. We work tirelessly to ensure we provide you with only the highest quality products backed by exceptional customer service. Because of this you can be assured you are in safe hands and will receive a service that is second to none. Give A. N. Wallis a call today and see why we are the new market leader in Earthing & Lightning Protection, Exothermic Welding and Surge Protection Products.

A. N. Wallis, another decision well made.



Using This Catalogue

This catalogue is designed to be as easy to use as possible. To help find the product you need, there is an alphabetical product index, a part number index and a product locator. Every product featured has its own technical and application drawings and a detailed product table. Materials specifications are also included.

Product Chapter: Earthing Earth Rods & Accessories

Product Section: Copperbond Earth Rods

Product Name: Copperbond Earth Rods

Dimensions: 10, 12, 16, 20, 25, 32, 40, 50, 63, 80, 100, 125, 160, 200, 250, 315, 400, 500, 630, 800, 1000

Part Number - Full Index See Pages 230 to 243.

Material Specification & Finishes: Standard copper finishes are 2024, Greater copper conductance are also available. Please contact the sales office for further information.

Technical Drawing: Application drawing showing a rod with a clamp.

Product Illustration: Three copper rods of different diameters.

Application Example: A rod with a clamp attached.

Material	Temp. Class	Temp. Range	Min. Size	Max. Size	Part No.	Price
2024	10	10	10	10	00010	00010
			12	12	00012	00012
		12	16	16	00016	00016
			20	20	00020	00020
			25	25	00025	00025
			32	32	00032	00032
	12	12	40	40	00040	00040
			50	50	00050	00050
		16	63	63	00063	00063
			80	80	00080	00080
			100	100	00100	00100
			125	125	00125	00125

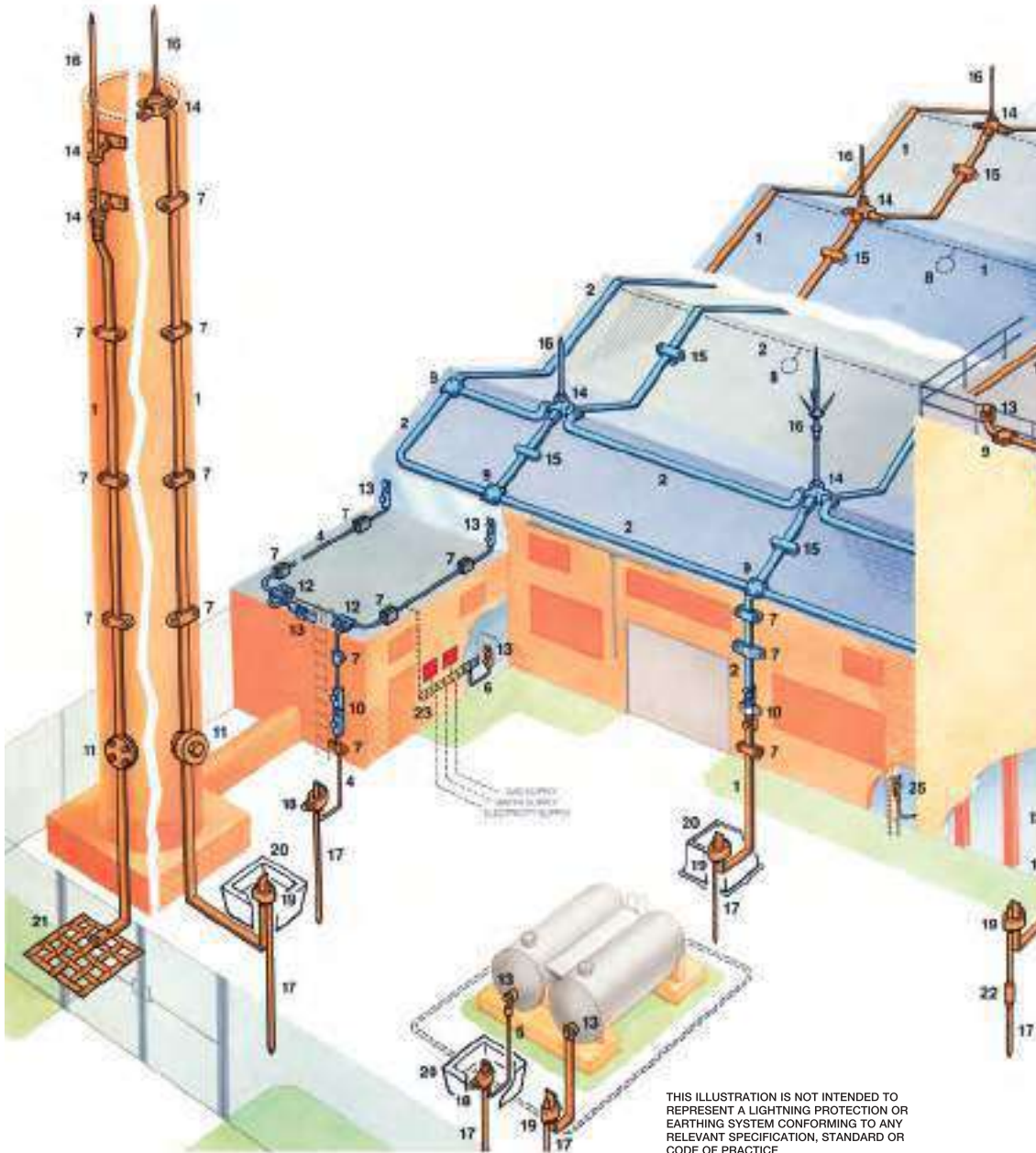

THIS ILLUSTRATION IS NOT INTENDED TO REPRESENT A LIGHTNING PROTECTION OR EARTHING SYSTEM CONFORMING TO ANY RELEVANT SPECIFICATION, STANDARD OR CODE OF PRACTICE



KEY

Item	Product	Page	Item	Product	Page
1	Bare Copper Tape	132-133	13	Bonding Clamps	94-95, 103-106
2	Bare Aluminium Tape	141	14	Air Terminal Fixings	77-79, 97, 107-109
3	PVC Covered Tape	134, 142	15	Slate Holdfasts	86, 97
4	Solid Circular Conductor	146-148	16	Air Terminals	76, 97, 107
5	Bare Stranded Copper Conductor	149	17	Earth Rods	24, 26, 28, 30, 32
6	PVC Insulated Stranded Copper Conductor	150	18	Earth Rod Clamps	34-35
7	Conductor Fixings	80-85, 98-100	19	Earth Inspection Housings	45-48
8	Strike Pads / Interceptor Plates	115-116	20	Earth Plates & Lattice Mats	42-43
9	Square Tape Clamps	93	21	Earth Rod Couplings	25, 27, 29, 31
10	Bi-Metallic Connectors	94, 103	22	Earth Bars & Disconnecting Link	54-60
11	Test Clamps	92-93	23	Flexible Copper Braid Bonds	66-69
12	'MV' Clamps	101	24	Earth Bonding Points	52-53

Introduction to Earthing & Earthing Designs

6



An earth electrode system, professionally designed by competent Engineers, is essential to ensure the safety of personnel and the protection of equipment from dangerous voltages in and around substations.

A. N. Wallis are able to offer earth electrode system designs and associated testing services using the most up-to-date equipment and design software 'CDEGS'. All this is carried out by competent and highly experienced Electrical Engineers and Technicians.

All design works are carried out in accordance with BS 7430:2011 – *The code of practice for protective earthing of electrical installations* and BS EN 50522:2010 – *Earthing of power installations exceeding 1kV a.c.* amongst other specifications.

All materials supplied by A. N. Wallis have been tested and certified by an independent body ensuring the highest quality materials are made available to you.



Earthing System Design Considerations

An earth electrode system should be designed to safely dissipate fault current or other unwanted electrical current to the general mass of earth. This could include power transmission and distribution, static dissipation, lightning protection as well as other associated systems.

The main considerations of an earth electrode system design should be:

1. Is the system safe and suitable for the purpose for which it is intended?
2. Is the system rated to carry the design fault currents?

To achieve this a number of steps are required and are detailed below.

Soil Resistivity Surveys

BS 7430:2011 states that 'on-site resistivity testing should always be carried out prior to carrying out an earth system design and installation'.

The soil resistivity survey is the first step in ensuring the correct design of an earth electrode system. It is essential that accurate measurements are taken at this stage as this data is used to determine what conductors are required in the finished earthing system to give a safe and suitable design. Corrupt data taken with inadequate test equipment could lead to a vastly over- or under-engineered solution.



A. N. Wallis use high specification test equipment to carry out soil resistivity testing, gaining data from tried and tested methods. This raw data is then analysed using CDEGS software to produce a representative electrical equivalent soil model which can then be used in the earthing design process.

Earth Electrode System Design

There are many factors that go into producing a compliant earth electrode system design: fault current levels, fault duration, ground make up and interconnected sites are but a few.

All of the parameters are analysed using the CDEGS software to ensure Touch, Step and Rise of Earth Potentials are within safe levels.

Our team of competent Engineers consider all of the above and more to ensure the final design is not only safe and suitable for its purpose, but also to ensure the system can be installed using the most economic processes giving you the most cost effective solution.



Overall System Testing

BS 7430:2011 states that 'all work should be carried out under the control and direction of a competent person.'

A. N. Wallis are able to offer test and inspection services for both new and existing installations. All works are carried out in accordance with BS 7430:2011 by our trained and competent Engineers and Technicians.

The period between periodic inspection and tests can only be determined by the environment that the system is installed in, for example the harsher the environment the more regular the inspection.

Please feel free to contact us to discuss your particular requirements.

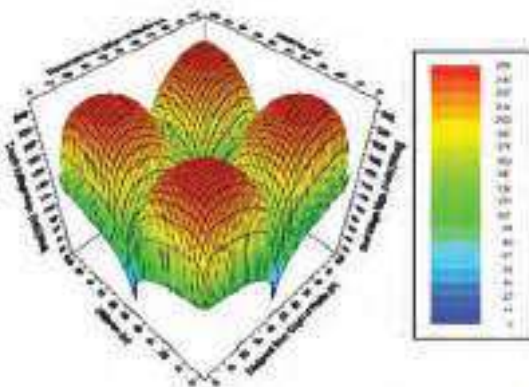

Introduction to Product Standards

The **International Electrotechnical Commission (IEC)** is the body responsible for implementing international standards. Its technical committee comprises of representatives from various member national standards, including **The European Committee for Electrotechnical Standardisation (CENELEC)**. IEC and CENELEC generally work in parallel, with CENELEC members voting to adopt new IEC standards as CENELEC standards. The important fact with CENELEC standards is that, by rule, the member countries are bound to adopt them as a national benchmark. In the process of adopting these standards, minimum changes are permitted. In-country clauses (exceptions or changes) can only be made under very strict circumstances. When such standards are adopted at the national level, any conflicting national standard must be withdrawn.

At each level (International, European, National) a different naming prefix convention is used, for example:

IEC 62561-1:2017 (the IEC version).

EN 62561-1:2017 (CENELEC adopted version of the above).

BS EN 62561-1:2017 (British Standard adopted version of the above).

All materials and components used in both Internal and External Lightning Protection systems must be designed, manufactured and tested for their respective electrical, mechanical and environmental (chemical) standards. Manufacturers and suppliers of lightning protection components should be able to provide test reports compliant to these standards. More importantly, the classification (class and environment) should be stated together within the scope of testing. Please note, the approval is only valid for the combinations of conductor sizes and configurations tested. **A. N. Wallis has successfully completed testing on a wide range of products, the results of which are available upon request.**

The below series of BS EN 62561 standards deal with the requirements and tests for lightning protection system components (LPSC) used in the installation of lightning protection systems (LPS) designed and implemented in accordance with the IEC / BS EN 62305 series of standards.

BS EN 62561-1:2017: Lightning Protection System Components (LPSC) – Part 1: Requirements for Connection Components

The above standard specifies the requirements and tests for all metallic connection components that form part of the lightning protection system (LPS). These include connectors, bridging components, bonding components, expansion pieces and test joints. The testing classifies the products according to their capability to withstand lightning current by an electrical test:

- Class H – Heavy Duty (tested with 100 kA 10/350 μ s), or
- Class N – Normal Duty (tested with 50 kA 10/350 μ s)

A classification is also made according to the installation of the component:

- Embedded in Concrete
- Not Embedded in Concrete.

BS EN IEC 62561 - 2:2018: Lightning Protection System Components (LPSC) – Part 2: Requirements for Conductors and Earth Electrodes (IEC 62561-2:2018).

The above standard specifies the requirements and tests for:

- Metallic conductors (other than “building natural down conductors”) that form part of the air termination system and down conductor system
- Metallic earth electrodes that form part of the earth termination system.

It should be noted that the metallic conductor requirements also cover air termination conductors, air-terminals (rods), earth lead in rods, down conductors and earth conductors.

The tests include measurements to confirm compliance with minimum size requirements, resistivity and environmental testing. Earth electrodes are subjected to tests including bend tests, adhesion tests, and environmental tests. Coupled earth electrodes and the coupling device are also subjected to hammer compression (impact testing).

BS EN 62561 - 3:2017: Lightning Protection System Components (LPSC) – Part 3: Requirements for Isolating Spark Gaps

The above standard specifies the requirements and tests for Isolating Spark Gaps (ISG) for lightning protection systems. ISGs can be used to indirectly bond a lightning protection system to other nearby metalwork where a direct bond is not permissible due to functional reasons, for example, earth termination systems of power installations; earth termination systems of telecommunication systems; rail earth electrode of AC and DC railways; installation with cathodic protection; and stray current protection.

BS EN 62561 - 4: 2017: Lightning Protection System Components (LPSC) – Part 4: Requirements for Conductor Fasteners

The above standard specifies the requirements and tests for metallic and non-metallic conductor fasteners that are used in conjunction with, and to secure the air-termination of, down conductor and earth termination systems. This standard does not cover the fixing of conductor fasteners to the fabric/membrane/gravel roofing of structures due to the vast number and types used in modern day construction.

BS EN 62561 - 5:2017: Lightning Protection System Components (LPSC) – Part 5: Requirements for Earth Electrode Inspection Housings and Earth Electrode Seals

The above standard specifies the requirements and tests for earth pits and earth seals made of steel, plastic, and concrete among other materials. Load-bearing capacity and seal quality are the key tests covered in the standard:

- Earth Electrode Inspection Housing (Earth Pit) – Metallic and Non-metallic enclosure that houses the down conductor/earth termination connection for inspection and testing purposes; consisting of a housing and a removable lid
- Earth Electrode Seals (Earth Seals) – Water Pressure Seal used in conjunction with an earth electrode that passes through the foundation of the building, so preventing ground water from entering.

**BS EN IEC 62561 - 6:2018: Lightning Protection System Components (LPSC)
– Part 6: Requirements for Lightning Strike Counters (LSC)**

20

The above standard specifies the requirements and tests for devices intended to count the number of lightning strike pulses flowing in a conductor. This conductor may be part of a lightning protection system (LPS) or connected to an SPD installation or other conductors, which are not intended to conduct a significant portion of lightning currents. Lightning Strike Counters are classified according to their application, threshold currents, maximum counting and withstand current. Mechanical, Electrical, and Corrosion tests along with UV radiation tests, IP rating tests, and Electromagnetic compatibility are addressed for LSC in this standard.

**BS EN IEC 62561 - 7:2018: Lightning Protection System Components (LPSC)
– Part 7: Requirements for Earthing Enhancing Compounds**

The above standard specifies the requirements and tests for earth enhancing compounds producing low resistance of an earth termination system. The material of the earth-enhancing compound shall be chemically inert to subsoil and not pollute. It should provide a stable environment in terms of physical and chemical properties and exhibit low resistivity, as well as not be corrosive to the earth electrodes/ conductors being used in the earth termination system. Backfill materials are not part of this standard. Tests included in the standard are conductivity, chemical (pH, solubility in acid environments), and composition (sulfur).

BS EN 62305 - 4: 2011: Protection against lightning – Part 4: Electrical and Electronic Systems within the structures

The above standard provides information for the design, installation, inspection, maintenance and testing of electrical and electronic system protection (i.e. SPM – Surge Protection Measure) to reduce the risk of permanent failures due to Lightning Electromagnetic Impulse (LEMP) within a structure. Protection of electronic and electrical systems against LEMP, which is the overall electromagnetic effects of lightning, including conducted surges (transient overvoltages and currents) and radiated electromagnetic fields, is an integral part of this standard. Lightning current and overvoltage SPD's, bonding and shielding form a total Surge Protection Measure (SPM) to effectively protect sensitive electronic and electrical systems from both lightning and switching transients.

IEC 61643 - 11: Surge Protective Devices connected to Low-Voltage power systems - Requirements and Test Methods

The above standard describes the requirements and test procedures of surge protective devices (SPDs) to ensure protection against the effects of direct and indirect lightning strikes or other transients.

IEC 61643 - 12: Surge Protective Devices connected to Low-Voltage Power distribution systems – Selection and Application Principles

The above standard must be used in conjunction with IEC 61643 -11. It provides information on the selection of Surge Protective Devices and information on the selection and co-ordination of SPDs. It also provides the principles of selection, operation, place of installation and co-ordination of SPDs connected to 50/60 Hz a.c. systems and equipment with nominal voltages up to 1000V (r.m.s).

IEC 61643 - 21: Surge Protective Devices connected to Telecommunications and Signalling Networks – Performance Requirements and Testing Methods

The above standard describes the requirements and test procedures for Surge Protection Devices used for the protection of telecommunication and signaling networks including data networks, alarm systems, voice transmission networks, computer communication interfaces, process control system, security systems.

IEC 61643 - 22: Surge Protective Devices connected to Telecommunications and Signalling Networks – Selection and Application Principles

The above standard must be used in conjunction with IEC 61643 -21. It provides information on the selection and application of Surge Protective Devices used to protect telecommunications and signalling networks.

OVERVIEW OF LPS AND LPSC STANDARDS FOR DESIGNING AND MATERIAL TESTING: -

Standard	Title	Type
BS EN 62305 - 1	Protection against lightning – Part 1: General Principles	Design Standard
BS EN 62305 - 2	Protection against lightning – Part 2: Risk Management	Design Standard
BS EN 62305 - 3	Protection against lightning – Part 3: Physical Damage to Structures and Life Hazard	Design Standard
BS EN 62305 - 4	Protection against lightning – Part 4: Electrical and Electronic Systems within Structures	Design Standard
BS EN 62561 - 1	Lightning Protection System Components (LPSC) – Part 1: Requirements for Connection Components.	Material Testing Standard
BS EN IEC 62561 - 2	Lightning Protection System Components (LPSC) – Part 2: Requirements for Conductors and Earth Electrodes.	Material Testing Standard
BS EN 62561 - 3	Lightning Protection System Components (LPSC) – Part 3: Requirements for Isolating Spark Gaps.	Material Testing Standard
BS EN 62561 - 4	Lightning Protection System Components (LPSC) – Part 4: Requirements for Conductor Fasteners.	Material Testing Standard
BS EN 62561 - 5	Lightning Protection System Components (LPSC) – Part 5: Requirements for Earth Electrode Inspection Housings and Earth Electrode Seals.	Material Testing Standard
BS EN IEC 62561-6	Lightning Protection System Components (LPSC) – Part 6: Requirements for Lightning Strike Counters.	Material Testing Standard
BS EN IEC 62561-7	Lightning Protection System Components (LPSC) – Part 7: Requirements for Earthing Enhancing Compounds.	Material Testing Standard
IEC 61643 - 11	Surge Protective Devices connected to Low-Voltage Power systems.	Testing Standard
IEC 61643 - 12	Surge Protective Devices connected to Low-Voltage Power distribution systems.	Selection & Application Standard
IEC 61643 - 21	Surge Protective Devices connected to Telecommunications and Signalling Networks.	Testing Standard
IEC 61643 - 22	Surge Protective Devices connected to Telecommunications and Signalling Networks.	Selection & Application Standard



Earth Rods & Accessories 24 - 33

Earthing Products 34 - 69

Static Earthing Products 70

Compression Connectors 71 - 73

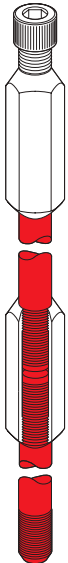

Copperbond Earth Rods

Wallis copperbond earth rods offer installers the most economical method of achieving a low earth resistance.

Each rod has a high tensile strength, low carbon steel core. 99.95% pure copper is applied electrolytically and forms a metallurgical bond between the steel core and the copper. This combination makes the rod ideal for deep driving whilst also provides lasting resistance to corrosion.

The threads are formed by a cold rolling process which ensures strength and maintains the molecularly bonded copper covering along the full length of the threads. Cold-rolled threads are stronger than cut-threads.

The standard copper thickness is 0.25mm. Greater copper thicknesses are also available. Please contact our sales office for further information.

Threaded

Nominal Size	L mm	Thread Size (UNC-2A)	Shank D mm	L1 mm	Unit Weight kg	Pack Quantity	Part Number
1/2"	1200	9/16"	12.7	30	1.18	5	ERB 412
	1500				1.55		ERB 415
	1800				1.76		ERB 418
	2400				2.36		ERB 424
5/8"	1000	5/8"	14.2	30	1.28	5	ERB 110
	1200				1.53		ERB 112
	1200			40	1.53		ERB 112S
	1500				1.95		ERB 115
	1800			30	2.23		ERB 118
	2400				3.00		ERB 124
	2400			40	3.00		ERB 124S
	3000				30		3.70
3/4"	1000	3/4"	17.2	35	1.65	5	ERB 200
	1200				2.20		ERB 212
	1500				2.76		ERB 215
	1800				3.26		ERB 218
	2400				4.45		ERB 224
	3000				5.48		ERB 230
1"	2400	1"	23.0	50	2.43	5	ERB 324
	3000				3.04		ERB 330

Material: Pure copper molecularly bonded onto a steel core

Unthreaded

Nominal Size	L mm	Shank D mm	Unit Weight kg	Pack Quantity	Part Number
3/8"	1200	9.5	0.62	5	ERB 012
1"	3000	25.4	22.50	5	ERB 930

Material: Pure copper molecularly bonded onto a steel core.



BS EN 62561-2

UL467



ERB424 ERB124 ERB130
ERB224 ERB230 ERB324

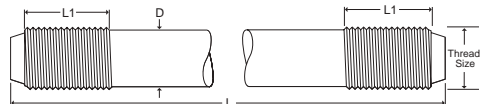

Threaded Couplings

These Wallis high-strength couplings are used for joining copperbond threaded earth rods together. They facilitate deep driving and ensure continual contact between the rods both during and after installation.

The coupling also protects the earth rod threads during installation with the threaded driving head. There is a lead-in for ease of assembly and the hexagonal design allows for grip and keeping the coupling tight when driving into the ground. All Wallis couplings are manufactured from a high copper content alloy ensuring excellent corrosion resistance.



Type	L mm	D mm	Unit Weight kg	Pack Quantity	Part Number
1/2"	68	18	0.07	25	ERBO 12
5/8"	68	20	0.12		ERBO 16
3/4"	78	25	0.14		ERBO 20
1"	100	31	0.25		ERBO 25

Material: High Copper Alloy

Type	L mm	D mm	Unit Weight kg	Pack Quantity	Part Number
5/8"	80	21	0.08	25	ERBO 16S

Material: Silicon Bronze.



BS EN 62561-1 Class H



Tightening torque 40 Nm

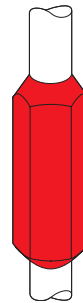
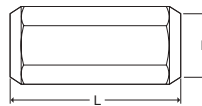

Threaded Driving Heads

These Wallis re-usable threaded driving heads are suitable for driving copperbond threaded earth rods by hand or with a power hammer. The driving head screws into the threaded coupling to allow deep driving of the earth rods.

Type	L mm	D mm	Unit Weight kg	Pack Quantity	Part Number
1/2"	50	20	0.08	25	ERBD 12
5/8"	55	22	0.08		ERBD 16
3/4"	60	25	0.13		ERBD 20
3/4"	120	22	0.30		ERBD 21*
3/4"	60	30	0.15		ERBD 25

Material: Steel.

* The ERBD 21 is a driving head with a 3/4" thread and a 5/8" head.



ERBD 16



ERBD 21

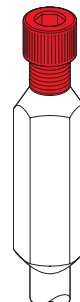

Type	L mm	D mm	Unit Weight kg	Pack Quantity	Part Number
5/8"	47	27	0.08	25	ERBD 16S

Material: Copper Coated Steel.

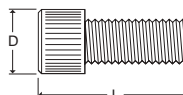

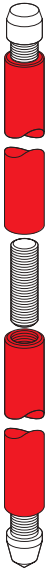
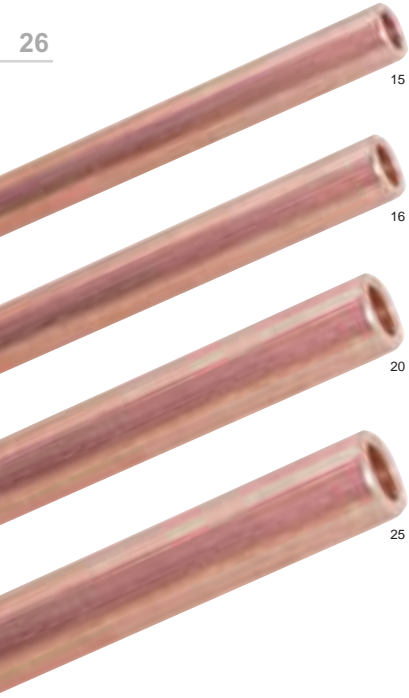

Solid Copper Earth Rods

These earth rods are designed for use where extremely high corrosion resistance and exceptionally long life are required. Solid copper earth rods are produced from solid copper bar and are internally threaded for jointing. When deep driving a solid copper earth rod the usual practice is to insert the rod into a bore hole and backfill with either Low-Resistance Earthing Compound or Bentonite, (see page 44 for further details).

Shank D mm	L mm	Thread Size	L1 mm	Unit Weight kg	Pack Quantity	Part Number
15	1200	M10	20	1.88	5	ERC 112
16	1500	M10	20	2.66	5	ERC 115
	1800			3.20		ERC 118
	2400			4.28		ERC 124
	3000			5.36		ERC 130
20	1200	M10	20	3.34	5	ERC 212
	1500			4.18		ERC 215
	1800			5.03		ERC 218
	2400			6.71		ERC 224
	2500			7.00		ERC 225
	3000			8.40		ERC 230
25	1000	M12	25	4.37	1	ERC 310
	1200			5.25		ERC 312
	1500			6.54		ERC 315
	1800			7.86		ERC 318
	2000			8.73		ERC 320
	2400			10.50		ERC 324
	2500			10.90		ERC 325
	3000			13.10		ERC 330
	3600			15.90		ERC 336

Material: Copper to BS EN 13601.



BS EN 62561-2

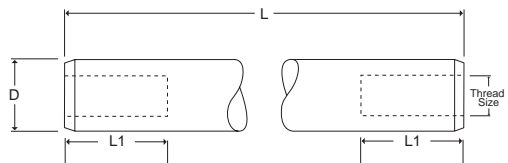

Driving Heads

The driving head protects the internal thread and the top of the solid copper earth rod from damage when being driven into the ground.

D mm	L mm	Thread Size	L1 mm	Unit Weight kg	Pack Quantity	Part Number
16	38	M10	20	0.03	25	ERCD 16
20	41	M10	20	0.06		ERCD 20
25	45	M12	25	0.10		ERCD 25

Material: Steel.

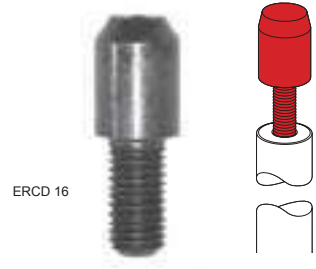
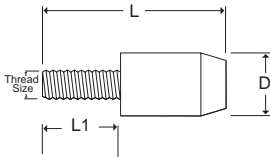

ERCD 16

Driving Spikes

These driving spikes enable solid copper earth rods to be driven easily into the ground.

D mm	L mm	Thread Size	L1 mm	Unit Weight kg	Pack Quantity	Part Number
16	42	M10	20	0.03	25	ERCS 16
20	51	M10	20	0.06		ERCS 20
25	60	M12	25	0.10		ERCS 25

Material: Steel.

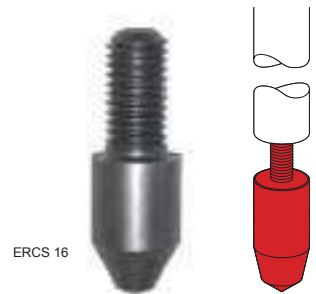
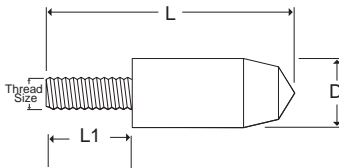

ERCS 16

Coupling Dowels

The phosphor bronze coupling dowel is used for joining solid copper earth rods together.

Thread Size	L mm	Unit Weight kg	Pack Quantity	Part Number
M10	40	0.02	25	ERD 01
M12	50	0.04		ERD 02

Material: Phosphor Bronze.



BS EN 62561-1 Class H

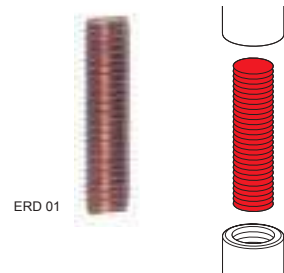
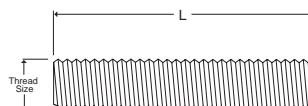

ERD 01

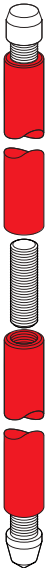
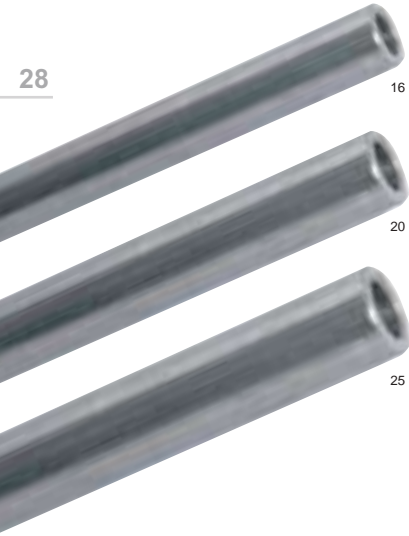

Tinned Solid Copper Earth Rods

The tinned solid copper earth rods are designed for use where extremely high corrosion resistance and exceptionally long life are required. Tinned solid copper earth rods are produced from solid copper bar and are internally threaded for jointing. When deep driving a tinned solid copper earth rod the usual practice is to insert the rod into a bore hole and backfill with either Low-Resistance Earthing Compound or Bentonite

Shank D mm	L mm	Thread Size	L1 mm	Unit Weight kg	Pack Quantity	Part Number
15	1200	M10	20	1.88	5	ERC 112T
	1500			2.66		ERC 115T
16	1800	M10	20	3.20	5	ERC 118T
	2400			4.28		ERC 124T
	3000			5.36		ERC 130T
				1200		3.34
20	1500	M10	20	4.18	5	ERC 215T
	1800			5.03		ERC 218T
	2400			6.71		ERC 224T
	2500			7.00		ERC 225T
	3000			8.40		ERC 230T
				1000		4.37
25	1200	M12	25	5.23	1	ERC 312T
	1500			6.54		ERC 315T
	1800			7.86		ERC 318T
	2000			8.73		ERC 320T
	2400			10.50		ERC 324T
	2500			10.90		ERC 325T
	3000			13.10		ERC 330T
	3600			15.90		ERC 336T

Material: Copper to BS EN 13601.

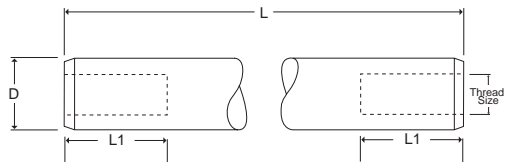

Driving Heads

The driving head protects the internal thread and the top of the tinned solid copper earth rods from damage when being driven into the ground.

D mm	L mm	Thread Size	L1 mm	Unit Weight kg	Pack Quantity	Part Number
16	38	M10	20	0.03	25	ERCD 16
20	41	M10	20	0.06		ERCD 20
25	45	M12	25	0.10		ERCD 25

Material: Steel.

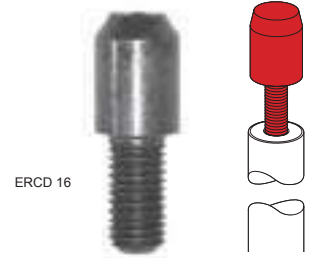
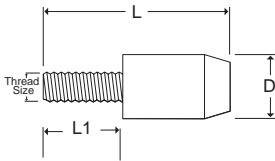

ERCD 16

Driving Spikes

These driving spikes enable tinned solid copper earth rods to be driven easily into the ground.

D mm	L mm	Thread Size	L1 mm	Unit Weight kg	Pack Quantity	Part Number
16	42	M10	20	0.03	25	ERCS 16
20	51	M10	20	0.06		ERCS 20
25	60	M12	25	0.10		ERCS 25

Material: Steel.

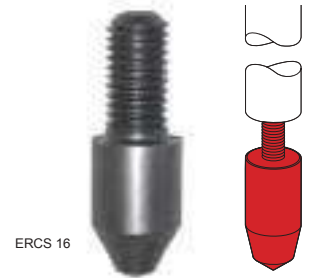
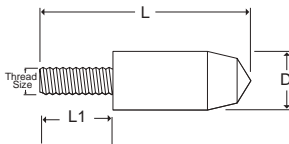

ERCS 16

Coupling Dowels

The phosphor bronze coupling dowel is used for joining tinned solid copper earth rods together.

Thread Size	L mm	Unit Weight kg	Pack Quantity	Part Number
M10	40	0.02	25	ERD 01
M12	50	0.04		ERD 02

Material: Phosphor Bronze



BS EN 62561-1 Class H

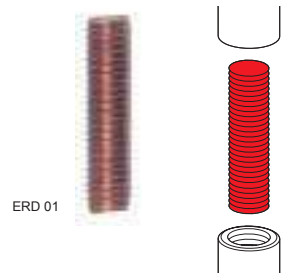
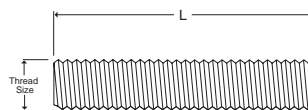

ERD 01

30

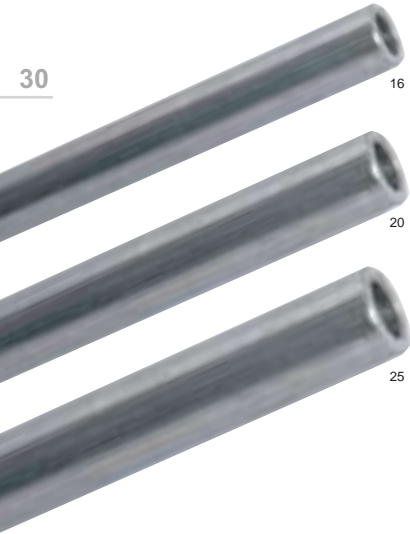

Stainless Steel Earth Rods

These earth rods are designed for use where problems may be caused by galvanic corrosion due to dissimilar metals being buried in close proximity. These earth rods are manufactured from Stainless Steel grade SS316 and are internally threaded for jointing, these earth rods are also highly resistant to corrosion

Shank D mm	L mm	Thread Size	L1 mm	Unit Weight kg	Pack Quantity	Part Number
16	1200	M10	20	1.87	5	ERZ 112
	1500			2.35		ERZ 115
	1800			2.83		ERZ 118
	2400			3.74		ERZ 124
	3000			4.75		ERZ 130
20	1200	M10	20	2.95	5	ERZ 212
	1500			3.79		ERZ 215
	1800			4.46		ERZ 218
	2400			6.10		ERZ 224
	3000			7.57		ERZ 230
25	1200	M12	25	4.64	1	ERZ 312
	1500			5.81		ERZ 315
	1800			6.99		ERZ 318
	2400			9.34		ERZ 324
	3000			11.69		ERZ 330

Material: Stainless Steel to BS EN 10088.



BS EN 62561-2

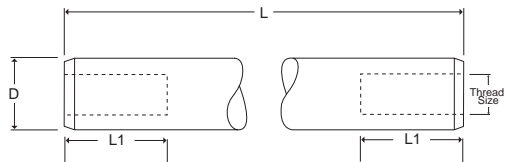
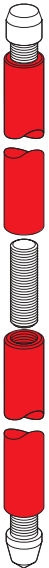

Driving Heads

The driving head protects the internal thread and the top of the stainless steel earth rod from damage when being driven into the ground.

D mm	L mm	Thread Size	L1 mm	Unit Weight kg	Pack Quantity	Part Number
16	38	M10	20	0.03	25	ERCD 16
20	41	M10	20	0.06		ERCD 20
25	45	M12	25	0.10		ERCD 25

Material: Steel.

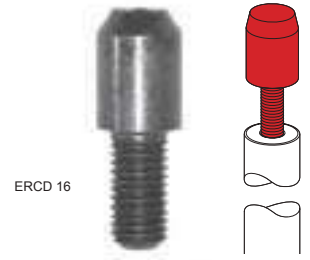
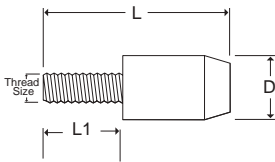

ERCD 16

Driving Spikes

These driving spikes enable stainless steel earth rods to be driven easily into the ground.

D mm	L mm	Thread Size	L1 mm	Unit Weight kg	Pack Quantity	Part Number
16	42	M10	20	0.03	25	ERCS 16
20	51	M10	20	0.06		ERCS 20
25	60	M12	25	0.10		ERCS 25

Material: Steel.

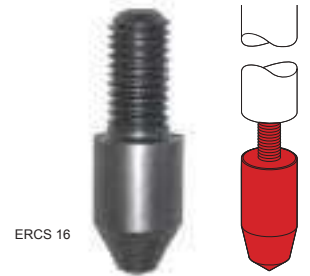
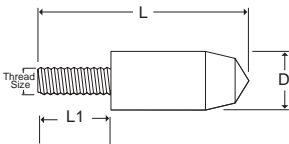

ERCS 16

Coupling Dowels

The stainless steel coupling dowel is used for joining stainless steel earth rods together.

Thread Size	L mm	Unit Weight kg	Pack Quantity	Part Number
M10	40	0.02	25	ERD 16
M12	50	0.04		ERD 25

Material: Stainless Steel.

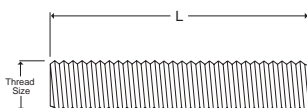

ERD 16



Galvanised Steel Earth Rod Set

This galvanised steel earth rod has a male thread at the top and a female thread at the bottom enabling rods to be joined together.

After machining, the rod is hot-dip galvanised with a coating of zinc not less than 610 g/m².

The rod is supplied as a standard set complete with toughened steel driving head, hardened steel driving spike and galvanised steel wire rope grip.

Nominal Size	L mm	Thread Size (BSF)	D mm	L1 mm	L2 mm	Unit Weight kg	Pack Quantity	Part Number
5/8"	1200	3/8"	16.5 - 17.0	30	25	2.10	5	ERG 112

Material: Mild Steel galvanised to BS EN ISO 1461.

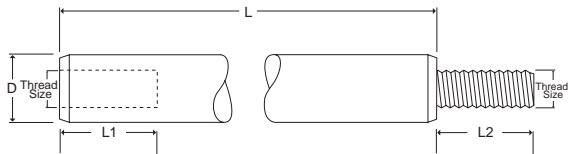

Overspike

These overspikes are compatible with Wallis copperbond earth rods (page 26) and are used when ground conditions are tough and when more assistance is required to drive the copperbond earth rod. An internal thread allows the overspike to easily connect to the earth rod.

Type	L mm	D mm	Unit Weight kg	Pack Quantity	Part Number
1/2"	50	19	0.05	25	ERBS 12
5/8"	47	24	0.07		ERBS 16
3/4"	47	24	0.07		ERBS 20



Material: Steel.

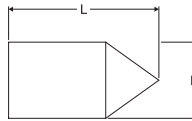

Earth Rod Driver

The ID110 is the ideal tool for earth rod driving where unfavourable ground conditions exist. With a rated power input of 1,700 W and a maximum impact energy of 23 J this item will help reduce earthing system installation times.

This item comes with an SDS Max bit holder and is compatible with the A. N. Wallis Heavy Duty Stainless Steel Earth Rod Driver attachment.



Rated Power Input W	Maximum Impact Energy J	Impact Rate at Rated Speed bpm	L mm	H mm	Unit Weight kg	Pack Quantity	Part Number
1,700	23	900 - 1,700	680	236	11.40	1	ID 110

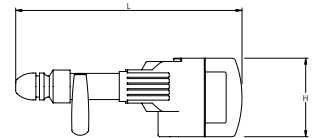

Heavy Duty (SDS Max) Stainless Steel Rod Driver Attachment

The A. N. Wallis heavy duty stainless steel earth rod driver attachment is suitable for both 5/8" and 3/4" Copperbond rods and up to 25mm solid copper / stainless steel rods.

Type	L mm	L1 mm	W mm	W1 mm	Unit Weight kg	Pack Quantity	Part Number
5/8"	205	70	38	18	0.65	1	ERD 058

Material: Stainless Steel

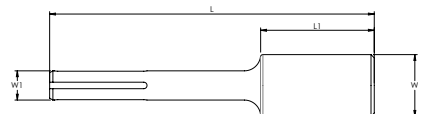



ERA 1625

ERA 2525

ERA 1631

ERA 1650



ERA 1625A

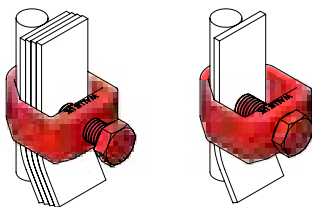

Earth Rod to Tape 'A' Clamps

These clamps are used for joining earth rods to different sizes of copper tape. The clamps have a high resistance to corrosion and are mechanically strong to ensure a lasting connection.

Earth Rod Shank Ø mm	Maximum Tape Size mm	L mm	W mm	H mm	Unit Weight kg	Pack Quantity	Part Number
12.7	26 x 15	43	36	19	0.12	50	ERA 1625
	32 x 15	42	44	18	0.13	25	ERA 1631
	39 x 15	46	52	23	0.20	25	ERA 1638
14.2	26 x 14	43	36	19	0.12	50	ERA 1625
	32 x 14	42	44	18	0.13	25	ERA 1631
	39 x 14	46	52	23	0.20	25	ERA 1638
	51 x 16	48	63	20	0.20	25	ERA 1650
15.0	26 x 13	43	36	19	0.12	50	ERA 1625
	32 x 13	42	44	18	0.13	25	ERA 1631
	39 x 13	46	52	23	0.20	25	ERA 1638
	51 x 15	48	63	20	0.20	25	ERA 1650
16.0	26 x 12	43	36	19	0.12	50	ERA 1625
	32 x 12	42	44	18	0.13	25	ERA 1631
	39 x 12	46	52	23	0.20	25	ERA 1638
	51 x 14	48	63	20	0.20	25	ERA 1650
17.2	26 x 11	43	36	19	0.12	50	ERA 1625
	32 x 11	42	44	18	0.13	25	ERA 1631
	39 x 11	46	52	23	0.20	25	ERA 1638
	51 x 13	48	63	20	0.20	25	ERA 1650
	26 x 18	54	38	22	0.17	10	ERA 2525
20.0	26 x 8	43	36	19	0.12	50	ERA 1625
	32 x 8	42	44	18	0.13	25	ERA 1631
	39 x 8	46	52	23	0.20	25	ERA 1638
	51 x 10	48	63	20	0.20	25	ERA 1650
	26 x 16	54	38	22	0.17	10	ERA 2525
25.0	26 x 11	54	38	22	0.17	10	ERA 2525

Material: Aluminium Bronze with M10 x 25mm Phosphor Bronze Set Screw.

*The ERA 1625 comes with a Stainless Steel Grade 316 Set Screw.

The aluminium version is mainly used for connecting aluminium tape to a puddle flange rod as part of a lightning protection system.

Earth Rod Shank Ø mm	Maximum Tape Size mm	L mm	W mm	H mm	Unit Weight kg	Pack Quantity	Part Number
16.0	26 x 12	45	37	19	0.06	25	ERA 1625A

Material: Aluminium with M10 x 25mm Stainless Steel Set Screw.



BS EN 62561-1 Class H



Tightening Torque 20 Nm

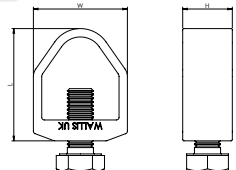

Earth Rod to Cable 'G' Clamps

These clamps are used for joining earth rods to different sizes of stranded copper conductor. The clamps have a high resistance to corrosion and are mechanically strong to ensure a lasting connection.

Earth Rod Shank Ø mm	Conductor Range mm	L mm	W mm	H mm	Unit Weight kg	Pack Quantity	Part Number
9.5	6 - 35	30	20	15	0.05	25	ERR 1035
12.7	6 - 35	36	28	18	0.07	25	ERR 1635
	35 - 70	41	26	20	0.08	50	ERR 1670*
14.2	6 - 16	36	28	18	0.07	25	ERR 1635
	16 - 70	41	26	20	0.08	50	ERR 1670*
	35 - 150	48	30	18	0.09	50	ERR 2095*
15.0	6 - 16	36	28	18	0.07	25	ERR 1635
	16 - 70	41	26	20	0.08	50	ERR 1670*
	25 - 150	48	30	18	0.09	50	ERR 2095*
16.0	6 - 70	41	26	20	0.08	50	ERR 1670*
	16 - 150	48	30	18	0.09	50	ERR 2095*
17.2	6 - 95	48	30	18	0.09	50	ERR 2095*
20.0	16 - 95	48	30	18	0.09	50	ERR 2095*

Material: High Copper Alloy with M10 x 25mm Phosphor Bronze Set Screw

* Suitable for use with 8mm Ø solid circular copper conductor.



BS EN 62561-1 Class H



Tightening Torque 12 Nm; ERR1635 13 Nm; ERR2095 20 Nm

ERR 1035



ERR 1635



ERR 1670



ERR 2095

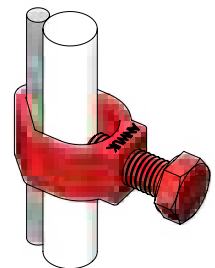
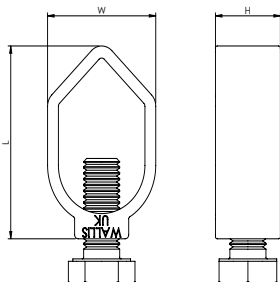

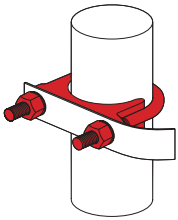

ERU 025

'U' Bolt Clamps

This versatile range of Wallis 'U' bolt clamps can be used to connect flat tapes and stranded cables to earth rods, reinforcing bars (rebar), hand rails etc.

Single Plate Type for Horizontal Flat Tapes

Used to connect flat tapes in a horizontal position on the rod.

Maximum Rod Ø mm	Hole Centres mm	L mm	W mm	H mm	Unit Weight kg	Pack Quantity	Part Number
16	30	58	62	33	0.17	20	ERU 016
25	37	72	62	33	0.19	20	ERU 025
31	41	82	68	33	0.25	10	ERU 031
38	46	90	75	33	0.29	10	ERU 038
50	63	95	90	33	0.39	5	ERU 050

Material: High Copper Alloy plate with M10 threaded Copper 'U' Bolt.

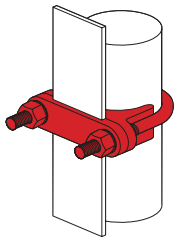

ERU 216

Double Plate Type for Vertical Flat Tapes

Used to connect flat tapes in a vertical position on the rod.

Maximum Rod Ø mm	Tape Width mm	L mm	W mm	H mm	Unit Weight kg	Pack Quantity	Part Number
16	25	58	62	33	0.23	20	ERU 216
25		73	60	33	0.23	10	ERU 225
31		85	68	33	0.32	10	ERU 231
38		80	75	33	0.34	10	ERU 238
50		103	90	33	0.53	5	ERU 250

Material: High Copper Alloy plates with M10 threaded Copper 'U' Bolt.

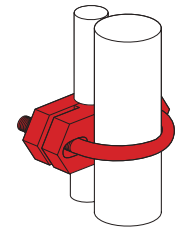

ERU 470

Double Plate Type for Vertical Stranded Cables

Used to connect stranded cables in a vertical and horizontal position on the rod.

Maximum Rod Ø mm	Conductor Range mm ²	L mm	W mm	H mm	Unit Weight kg	Pack Quantity	Part Number
16	16 - 150	57	52	40	0.21	20	ERU 470
	150 - 300	69	70		0.30	10	ERU 570
20	16 - 70	57	52	40	0.21	20	ERU 470
	70 - 300	69	70		0.30	10	ERU 570
25	16 - 70	75	87	55	0.52	5	ERU 670
	185 - 300	89	70		0.46	7	ERU 770

Material: High Copper Alloy plates with M10 threaded Copper 'U' bolt.
The ERU470 has an M8 threaded Copper 'U' bolt.



BS EN 62561-1 Class H



Tightening torque 20 Nm; ERU470 13 Nm; ERU770 12 Nm

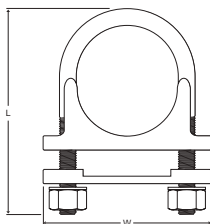
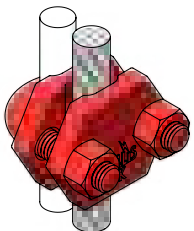

Split Connector Clamps

Split connector clamps are used to connect cable lugs onto earth rods. The clamps are designed to suit our full range of earth rods. All clamps are assembled with an M12 x 50mm set screw and fittings, except ERS010 which has an M8 x 40mm set screw and fittings. ERC24 also has a wing nut.

For use with Copperbond Earth Rods (on rod thread)

Nominal Rod Size	Thread Size (UNC-2A)	L mm	W mm	H mm	Unit Weight kg	Pack Quantity	Part Number
5/8"	5/8"	42	24	26	0.21	10	ERS 016
3/4"	3/4"	51	31	30	0.34		ERS 020

Material: High Copper Alloy.

For use with Copperbond Earth Rods (on rod shank)

Rod Shank Ø mm	L mm	W mm	H mm	Unit Weight kg	Pack Quantity	Part Number
9.5	26	16	20	0.07	10	ERS 010
14.2	42	25	25	0.26		ERC 24

Material: High Copper Alloy.

For use with Solid Copper & Stainless Steel Earth Rods (on rod shank)

Rod Shank Ø mm	L mm	W mm	H mm	Unit Weight kg	Pack Quantity	Part Number
15	42	26	25	0.21	10	ERC 26
16	42	25	26	0.21		ERSS 16
20	54	29	29	0.23		ERSS 20

Material: High Copper Alloy.



BS EN 62561-1 Class H

ERS 016



ERC 24



ERSS 20

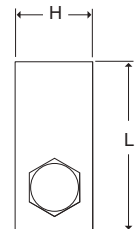
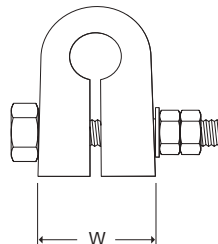
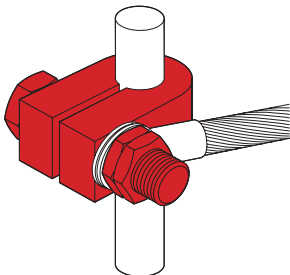



'U' Bolt Clamp

This unique specially designed 'U' bolt clamp is used to connect 1, 2 or 3 stranded cables to the earth rod. The "V" seat of the clamp pushes the earth rod to self-centre itself, which eliminates any movement in the fitting. The clamp is designed for earth rods between 16-20mm diameter and will accept stranded conductors ranging from 70sqmm to 150sqmm.

Maximum Rod Ø mm	Conductor Size mm ²	L mm	W mm	H mm	Unit Weight kg	Pack Quantity	Part Number
16 - 20	70 - 150 x 3	72	80	35	0.40	10	ERU 370

Material: High Copper Alloy.

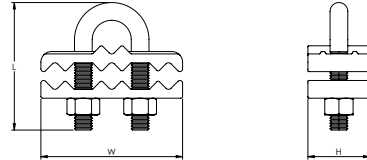
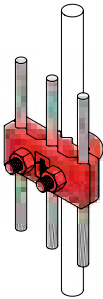

Universal Beam Clamp

This Universal Beam Clamp is a unique product as it is designed to bond 25x3mm copper tape, 50sqmm and 70sqmm stranded cable as well as 8mm solid circular conductor to steel beams and RSJ's of up to 15mm thick.

No other product on the market offers this range of alternatives when bonding to steel beams and RSJ's.

Its robust design allows multiple connections without compromise to the strength or quality

Conductor Range mm ²	Conductor Size mm	L mm	W mm	H mm	H1 mm	Unit Weight kg	Pack Quantity	Part Number
50 - 70	25 x 3	80	43	35	18	0.39	8	UBC 001

Material: High Copper Alloy with Stainless Steel Bolts.

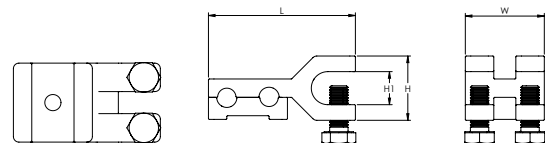
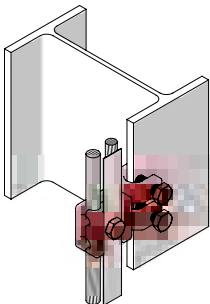

Multi-Purpose Rod to Cable & Tape Clamp

The GTI254 has been specifically designed to accommodate copper tape, stranded copper and copperbonded earth rods and is primarily used on High Voltage applications.

Rather than use the standard U bolt concept, the GTI254 uses a variant that allows the earth rod to self-centre in the clamp assembly, which reduces the amount of movement in the fitting.

With the inclusion of slots in the back plate on both plates, customers have the ability to install the tape either horizontally or vertically without the need to punch the tape to accept the fixing bolts.

The concept of the GTI254 is to simplify the connection by reducing the number of components required, therefore reducing the time needed to install the equipment.

The design of this unique item has been registered with the UK IPO office under number 4 043 590.



Maximum Rod Ø mm	Conductor Range mm ²	Conductor Size mm	L mm	W mm	H mm	Unit Weight kg	Pack Quantity	Part Number
5/8"	6 - 185	25 x 4	72	83	66	0.55	5	GTI254

Material: High Copper Alloy plates with M10 threaded Copper 'U' Bolt.



BS EN 62561-1 Class H



Tightening torque 20 Nm



Registered Design No 4 043 590

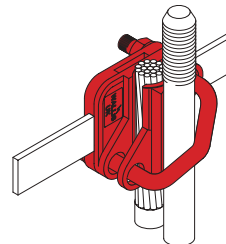
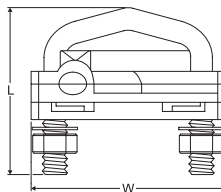
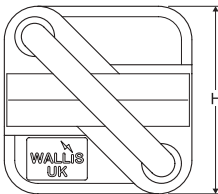

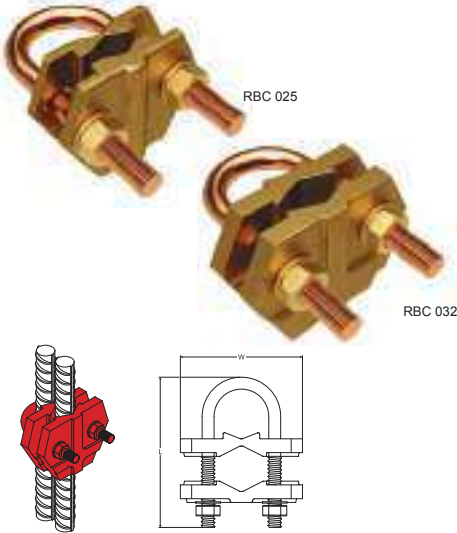

Rebar Clamps

This versatile range of Wallis Rebar clamps are used to connect rebar to rebar or rebar to stranded cable. They provide a strong mechanical connection along with excellent resistance to corrosion.

Maximum Rebar Ø mm	Rebar Range Ø mm	L mm	W mm	Unit Weight kg	Pack Quantity	Part Number
10	6 - 10	59	60	0.21	5	RBC 010
20	12 - 20	83	62	0.36	5	RBC 020
25	20 - 25	100	67	0.42	5	RBC 025
32	25 - 32	101	80	0.60	5	RBC 032
40	32 - 40	118	95	0.70	5	RBC 040

Material: High Copper Alloy plates with Copper 'U' Bolt.



BS EN 62561-1 Class H



Tightening torque 20 Nm

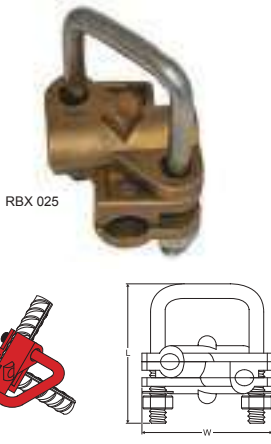

Rebar X Clamp

A heavy duty rebar clamp designed specifically to connect a vertical rebar to a horizontal rebar in a cross configuration. This product provides a strong mechanical connection along with excellent resistance to corrosion.

Maximum Rebar Ø mm	Rebar Range Ø mm	L mm	W mm	Unit Weight kg	Pack Quantity	Part Number
25	12 - 25	91	75	0.52	5	RBX 025

Material: High Copper Alloy Plates with Stainless Steel 'C' Bolt.



Stainless Steel Rebar Clamps

This versatile range of Wallis Rebar clamps are used to connect rebar to rebar or rebar to conductor. They provide a strong mechanical connection along with excellent resistance to corrosion. These items are made from stainless steel and are simple to install.

Maximum Rebar Ø mm	Rebar Range Ø mm	L mm	W mm	Unit Weight kg	Pack Quantity	Part Number
12	8 - 12	50	22	0.05	10	RBS 012
16	16 - 16	59	22	0.05	10	RBS 016
20	20 - 20	68	26	0.06	10	RBS 020
25	25 - 25	81	31	0.07	10	RBS 025
32	32 - 32	98	39	0.07	10	RBS 032
40	40 - 40	120	48	0.08	10	RBS 040

Material: Stainless Steel.

Pipe Clamps

These heavy duty pipe clamps are ideal for bonding and connecting cable conductor to large diameter pipework's. They are suitable for use with copper, steel or stainless steel pipes.

Available in aluminium on request.



Pipe Diameter	Conductor Range mm ²	Unit Weight kg	Part Number
½" - 1" (13 - 25mm)	25 - 95	0.03	PCL 025
1 ¼" - 2" (32 - 50mm)	25 - 95	0.04	PCL 050
2 ½" - 3 ½" (65 - 90mm)	25 - 95	0.08	PCL 090
4" - 5" (100 - 125mm)	25 - 95	0.06	PCL125
6" (150mm)	25 - 95	0.08	PCL 150
8" (200mm)	25 - 95	0.10	PCL 200
10" (250mm)	25 - 95	0.11	PCL 250
12" (300mm)	25 - 95	0.15	PCL 300

Material: Tinned Bronze

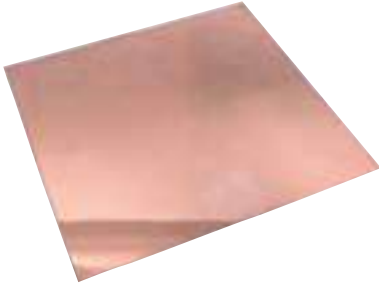

Solid Copper Earth Plates

Solid copper plates provide a long lasting earthing solution in places where driving earth rods might be impractical. They are often installed in conjunction with Low-Resistance Earthing Compound or Bentonite.

L x W mm	H mm	Surface Area m ²	Unit Weight kg	Pack Quantity	Part Number
600 x 600	1.5	0.73	4.80	1	EMP 601
	3.0		9.60		EMP 603
900 x 900	1.5	1.63	10.80	1	EMP 901
	3.0		21.60		EMP 903
1000 x 500	5.0	1.02		1	EMP 10005005

Material: Copper to BS EN 1652:1998.

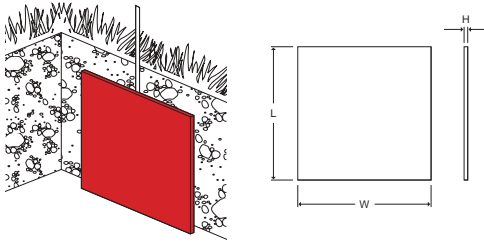

BS EN 62561-2

Solid Copper Lattice Mats

Solid copper lattice mats offer a more economical cost option to installing solid copper plates.

They are often used for potential grading and are a preferred option on installations such as telecommunication towers, where touch and step potential could cause problems.

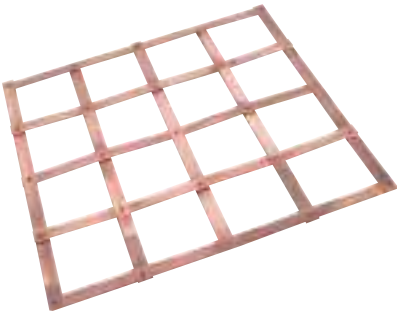

L x W mm	H mm	Surface Area m ²	Grid	Unit Weight kg	Pack Quantity	Part Number
600 x 600	3.0	0.31	5 Bar	4.00	1	EML 603
		0.65	6 Bar	7.20		EML 903
900 x 900	3.0	0.46	6 Bar	6.10	1	EML 903 SPC

Material: Copper to BS EN 13601 (formerly BS 1432).



BS EN 62561-2

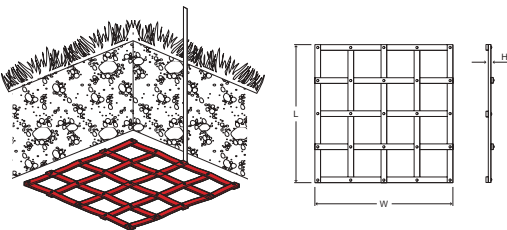

Stainless Steel Lattice Mats

Stainless Steel Lattice Mats, manufactured from Stainless Steel 316 Grade, are used in areas where a high corrosive environment is present.

They are often used for potential grading and are a preferred option on installations such as telecommunication towers, where touch and step potential could cause problems.



L x W mm	H mm	Surface Area m ²	Grid	Unit Weight kg	Pack Quantity	Part Number
600 x 600	3.0	0.31	5 Bar	6.10	1	EML 603SS
		0.55	10 Bar	-		EML 603SS/10
900 x 900	3.0	0.65	6 Bar	7.30	1	EML 903SS
		0.89	10 Bar	-		EML 903SS/10
900 x 900	5.0	0.56	6 Bar	-	1	EML 905SS

Material: Stainless Steel to SS316 Grade and SS316 Rivets.

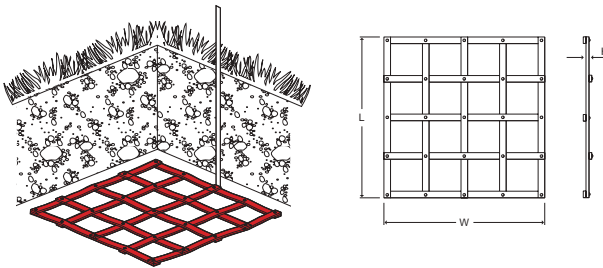

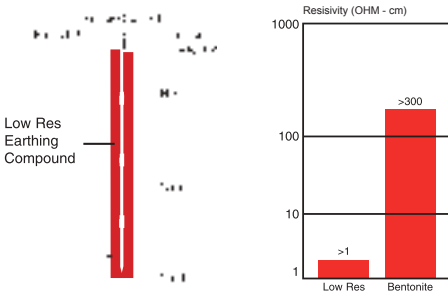

Low Res

Wallis **Low Res** provides a permanent simple solution to substantially lower the resistance of an earthing system.

It is a high performance low-resistance earthing compound which when mixed with cement and water forms a high strength electrically conductive concrete to last for the life of the system.

Low Res is supplied in a fine granular form available in 25kg bags. It is widely used in earthing and grounding applications where permanent low resistance and high compressive strength solutions are required.

By mixing **Low Res** with cement at a ratio of 2:1 the resulting concrete is electrically conductive whilst offering a solid electrical connection between the earthing system and the ground.

To use **Low Res** without concrete simply mix with water into a slurry for holes or a firm mix for trenches.

Low Res is a non leaching, maintenance free stable earthing compound ideal for use in ground conditions where conductivity is very poor such as rock or shale. **Low Res** provides a permanent path for excellent conduction of current instead of attempting to employ large diameter difficult to drive earth rods.

Low Res applications include static control for aircraft aprons and fuel tankers, RF and microwave screening and earthing for a wide variety of applications in Oil and Gas installations, Telecommunications industry, Defence Establishments, Rail and Underground installations, Electricity and Water Companies.

Low Res is the permanent effective and simple solution.

Type	Unit Weight kg	Pack Quantity	Part Number
Low Res Earthing Compound Only	25	1 Bag	EMA 25
Low Res Earthing Compound Pre Mixed with Cement	25		EMA 26



BS EN 62561-7

Bentonite

Bentonite is a moisture retaining clay used as an earth electrode back-fill to help lower soil resistivity. The clay is a sodium activated montmorillonite, which when mixed with water swells to many times its original dry volume. While there is no specific mixing ratio, we recommend gradually adding Wallis Bentonite to water in a mixing vessel, agitate to evenly disperse the Bentonite and continue mixing until there is a workable slurry that suits the site, hole or trench.

Bentonite can be supplied in granular or powder form. The granular form is easier to handle as the powder can cause dust in windy conditions. Granular is the preferred option for filling trenches as the substance can be mixed in the trench. Powder is the preferred option for pouring into bore holes to ensure the mixture is a thin enough consistency to reach the bottom of the hole.

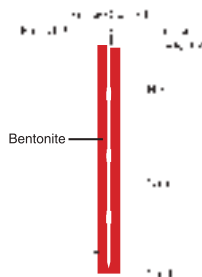

Type	Unit Weight kg	Pack Quantity	Part Number
Bentonite Granular Form	25	1 Bag	EBG 25
Bentonite Powder Form			EBG 25P

Heavy Duty Earth Inspection Housings

The Wallis 'lightweight' (3kg) but heavy duty earth housing has the best safe working load performance in the industry. It has been designed, shaped and sized to fit easily into brick paved walkways. The lip of the base makes a flush fit with standard-sized bricks, making the housing blend in without the need for a cement surround. The housing will withstand loads of up to 6,000 kgs and is suitable for most commercial and industrial applications. The lid locks into the base and can be opened with a standard flat screwdriver. The base has three built in slots for locating earth bars.



EPP 001 W



EPP 002 W

Lid Colour	L x W mm	H mm	L1 x W1 mm	H1 mm	Unit Weight kg	Pack Quantity	Part Number
Black	306 x 306	216	260 x 260	55	3.0	1	EPP 001 W
Grey							EPP 002 W
Green							EPP 100 W
Terracotta							EPP 200 W

Material: Polypropylene base with GRP lid.



BS EN 62561-5

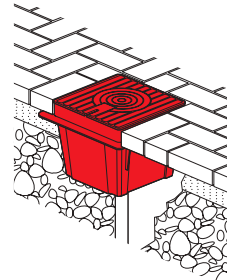
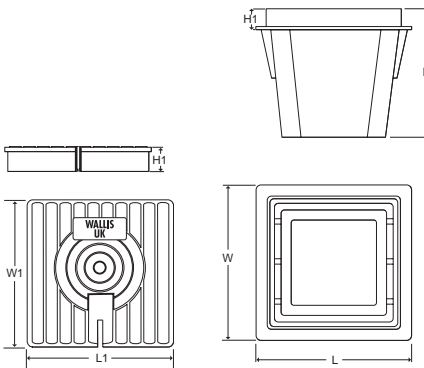

Inspection Housing Earth Bars (for Heavy Duty Earth Inspection Housings)

These earth bars fit into the slots provided in the heavy duty earth inspection housings and are used when multiple connections to the earth rod are required.

No. Holes	Hole Ø mm	L mm	W mm	H mm	Unit Weight kg	Pack Quantity	Part Number
5	11	203	25	6	0.24	1	EBC 35
7					0.22		EBC 37

Material: Copper to BS EN 13601.



BS EN 62561-1 Class H



Tightening torque 20 Nm

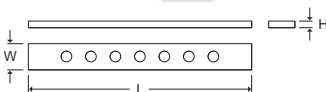

EBC 35

EBC 37

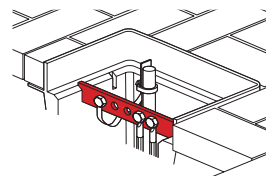



ERH 21



ERH 20

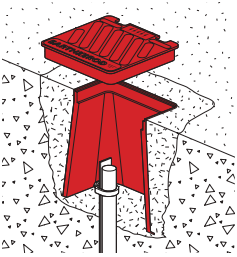

Light Duty Earth Inspection Housings

The Wallis light duty earth inspection housing has a maximum safe working load of 2,000 kilograms. It is UV stabilised against degradation by sunlight and non-brittle to prevent cold weather damage.

The unique, detachable easy-locking lid ensures security of equipment as the locking mechanism can only be operated by the special key provided with the housing. The base has built-in slots for locating earth bars.

Its lightweight feature allows easy handling, storage and transportation. The termination depth is increased 100% by simply locking two units together, allowing deeper earth electrode connections to be made.

Lid Colour	L x W mm	H mm	L1 x W1 mm	Unit Weight kg	Pack Quantity	Part Number
Black	260	230	200	1.50	1	ERH 20
Grey						ERH 21

Material: Polypropylene.



BS EN 62561-5

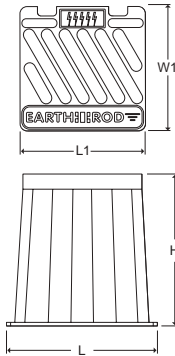
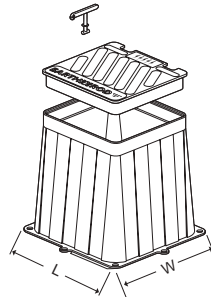

Inspection Housing Earth Bars (for Light Duty Earth Inspection Housings)

These earth bars fit into the slots provided in the light duty earth inspection housings and are used when multiple connections to the earth rod are required.

No. Holes	Hole Ø mm	L mm	W mm	H mm	Unit Weight kg	Pack Quantity	Part Number
5	11	250	30	6	0.42	1	EBC 25
7					0.39		EBC 27

Material: Copper to BS EN 13601.



BS EN 62561-1 Class H



Tightening torque 20 Nm

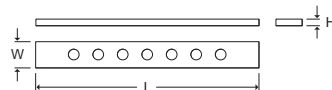

EBC 27

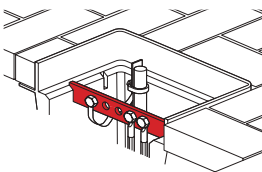

Concrete Earth Inspection Housing

The Wallis concrete inspection pits are load rated to 4,500kg and are suitable for most types of earthing and lightning protection installations.

Lids are available in 2 types, one with a central lifting eye for industrial applications. The other with a unique plain lid non trip surface ideal for public and pedestrian areas, shopping arcades, supermarket forecourts, Mosques and cinemas where trip hazards are a potential problem.

The base is designed to accept a diagonal earth bar with 5 or 7 terminations (EBC05 and EBC07).

If an alternative high load inspection pit is required the Heavy Duty Inspection Pit (EPP001W) is recommended. Ideal for areas where high loads or small wheel vehicles are used, rated up to 6,000kg, lockable and available in black or grey.



Lid Type	L mm	W mm	H mm	Unit Weight kg	Pack Quantity	Part Number
Non Trip Plain Lid	315	315	160	24	1	ERH 01W
Central Lifting Eye			185	26		ERH 02W
Central Lifting Eye	315	315	185	26		ERH 07W
Non Trip Plain Lid	450	450	450	72		ERH 450

Material: Concrete.



BS EN 62561-5

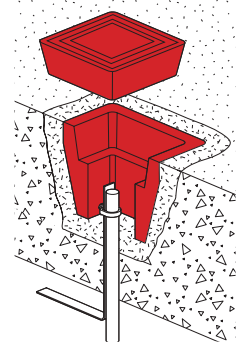
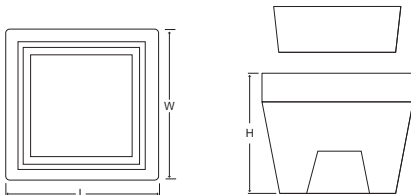

Inspection Housing Earth Bars (for Concrete Earth Inspection Housings)

These earth bars fit into the slots provided in the concrete inspection housings and are used when multiple connections to the earth rod are required.

No. Holes	Hole Ø mm	L mm	W mm	H mm	Unit Weight kg	Pack Quantity	Part Number
5	11	285	30	6	0.49	1	EBC 05
7					0.50		EBC 07

Material: Copper to BS EN 13601.



BS EN 62561-1 Class H



Tightening torque 20 Nm



EBC 07

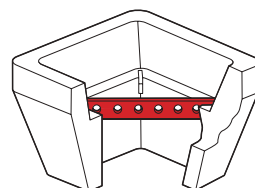
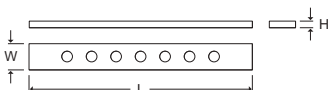

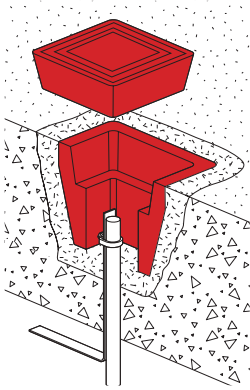

Concrete Earth Inspection Housing with Stainless Steel Plate

This Wallis concrete earth inspection housing also comes complete with a Stainless Steel tag or identification label. These Wallis concrete pits are becoming increasingly common and are used on large sites where pit location and identification is important. Wallis have supplied these concrete pits to Shell petrochemical plants in Nigeria, water authorities in UAE as well as rail authorities in the UK and are bespoke to the client's needs. We offer various numbering, various wording and various languages including Arabic.

The base is designed to accept a diagonal earth bar with 5 or 7 terminations (EBC05 and EBC07).

Lid Type	L mm	W mm	H mm	Unit Weight kg	Pack Quantity	Part Number
Non Trip Plain Lid	315	315	160	24	1	ERH 03W

Material: Concrete.

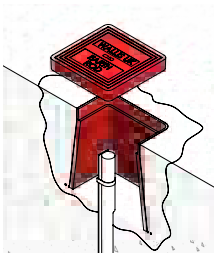
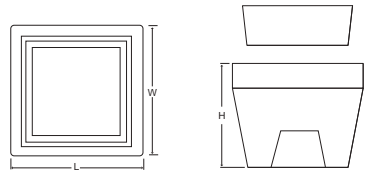

Heavy Duty Earth Inspection Housing with Concrete Lid

The Wallis 'lightweight' but heavy duty earth housing is available with a concrete lid. Clients often prefer the convenience of the lightweight pit for transportation, freight and handling along with the assurance of the colour of the concrete lid as the colour and texture of the concrete lid blends well with the surrounding cement. This hybrid pit is load rated to 4,500 kilograms and is suitable for most commercial and pedestrian applications. The base has three built-in slots for locating earth bars.

Lid Type	L x W mm	H mm	L1 x W1 mm	Unit Weight kg	Pack Quantity	Part Number
Central Lifting Eye	306	216	90 x 90	8.60	1	ERH 10L

Material: Polypropylene with a Concrete Lid.

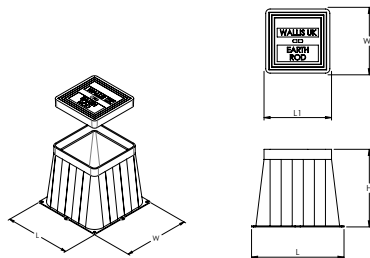

Tower Earth Clamps

Tower earth clamps are used for bonding copper conductors onto steel surfaces.

The double-plate design provides a robust fixing in areas where cladding may be installed or where the complete clamp will be covered by concrete. The clamp is fixed by drilling a hole in the steelwork and securing with the set screw provided.

Conductor Range mm ²	L mm	W mm	H mm	Set Screw	Unit Weight kg	Pack Quantity	Part Number
16 - 70	45	30	17	M10 x 50mm	0.12	10	BTC 070
70 - 120	48	35	22	M12 x 60mm	0.23		BTC 120
120 - 185	55	40	28	M12 x 75mm	0.30		BTC 185
185 - 240	63	45	35	M12 x 80mm	0.40		BTC 240
240 - 300	70	53	42	M12 x 90mm	0.60		BTC 300

Material: High Copper Alloy.



BS EN 62561-1 Class H

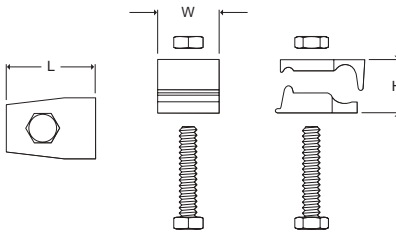

BTC 070

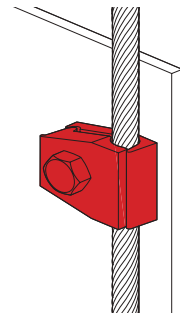

Parallel Groove Clamps

Wallis Parallel Groove Clamps, for stranded copper cable connections, are manufactured from high-strength, corrosion-resistant copper alloy and assembled with two stainless steel set screws.

Conductor Range mm ²	L mm	W mm	H mm	Set Screw	Unit Weight kg	Pack Quantity	Part Number
25 - 70	50	40	7	M8 x 35mm	0.38	10	PGC 070
70 - 95	54	45	8.5	M10 x 45mm	0.46		PGC 095
95 - 185	65	57	12.5	M10 x 55mm	0.55		PGC 185
185 - 240	78	71	14	M10 x 55mm	0.66		PGC 240
240 - 300	94	85	16	M10 x 60mm	0.78		PGC 300

Material: High Copper Alloy.

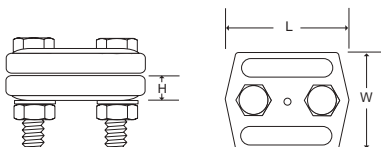

PGC 095

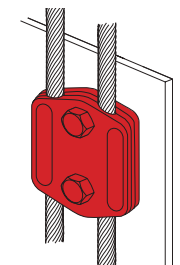



WES 001



WES 002



WES 003



WES 004

Earth Rod Seals

The Wallis market leading range of earth rod seals are simply the best available in the industry offering 4 variations with very few components, extremely robust and simple to install.

Office blocks in modern cities are frequently adjoined therefore requiring earth rods to be located within the building footprint. In such cases earth rods are usually installed in the basement or underground car park, which requires the earth rod to pass through the buildings floor slab and water proof membrane. In such cases in order to prevent water ingress an earth rod seal is required around the earth rod. The Wallis earth rod seals are purpose designed to meet this need. They are extremely robust offering heavy duty sealing as well as being simple to install.

The Wallis earth rod seals offer superior features and benefits:

- Simple to install - Easy to align and no concerns with damaged O rings or leaks
- One seal fits all – One seal fits all diameters of earth rods and does not require complicated adaptor kits
- Extremely robust - Damage during installation is highly unlikely
- Very few components - With minimal components for each earth rod seal the risk of lost parts is effectively eliminated
- Very adaptable - Wallis earth rod seals give the designer/installer the convenience of being able to use this product with:
 - A Wallis heavy duty plastic inspection pit
 - A Wallis concrete inspection pit
 - No inspection pit at all
 - Other seals in the industry are limited for use solely with plastic pits and have a large number of (easy to damage) small components.
- Can be used in concrete slabs of up to 3m thick (3m tube available on request)
- Complies with BS EN 62305-3 and BS EN 62561-5 (Requirements for earth electrode inspection housings and earth electrode seals)
- Sealing in all directions - The Wallis sealing component has the unique mechanical effect of sealing in all directions. It pushes out towards the body of the sealing unit and in towards the earth rod electrode giving maximum surface area contact
- No metallic parts - As the Wallis earth rod seals are supplied with no metallic parts this offers total corrosion resistance and prevents unwanted maintenance costs
- Compatible with all Wallis earth rods - The simple unique design allows the earth rod seal to be used on all rod types, solid copper, copperbonded and stainless steel as well as all rod sizes.
- Guarantee - We provide a warranty for this product for 36 months, no other product in the industry offers all of the above

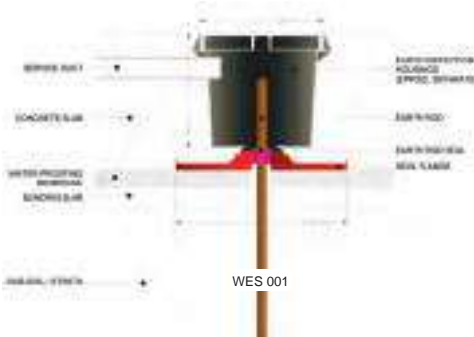

WES 001

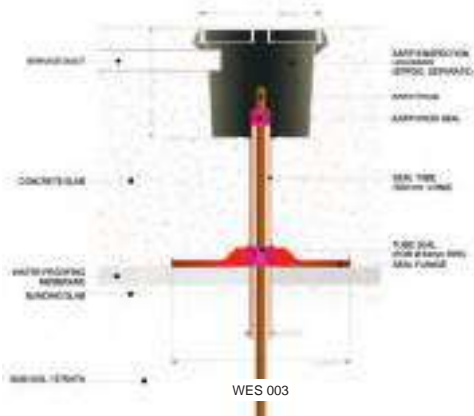

WES 003

Earth Rod Seals (Continued)

Type	Earth Rod Ø mm	Tube Length mm	Unit Weight kg	Pack Quantity	Part Number
Single Flange with gland nut	14.2	n/a	1.32	1	WES 001
Double Flange, both with gland nuts	15	n/a	2.61		WES 002
Single Flange with top seal and 300mm long pipe	16	300	1.58		WES 003
Single Flange with top seal and 1200mm long pipe	17.2	1200	2.27		WES 003/1200
Double Flange with gland nut and 1200mm long pipe	20	1200	2.82		WES 004/1200

*All seals suitable for use with 14.2, 15, 16, 17.2 and 20mm diameter earth rods.

*Tubes available in any length up to 3m long, please specify.

Material: Plastic



BS EN 62561-5

Earth Bonding Points

These Wallis earth bonding points are installed to provide a convenient earth system connection point in concrete structures. When cast into concrete they connect the re-bar to the earthing or lightning protection system.

Earth Bonding Points only

No. Holes	Hole Size mm	Plate Size mm	Stem Ø mm	L mm	Unit Weight kg	Pack Quantity	Part Number
1	M10 x 18	38 x 38	10.7 (70mm ²)	75	0.14	10	EGP 01
2		70 x 35			0.29		EGP 02
4		63 x 63			0.54		EGP 04
	M8 x 1.25 100 x 100	73	EGP 041				

Material: High Copper Alloy.



BS EN 62561-1 Class H



Tightening torque 20 Nm

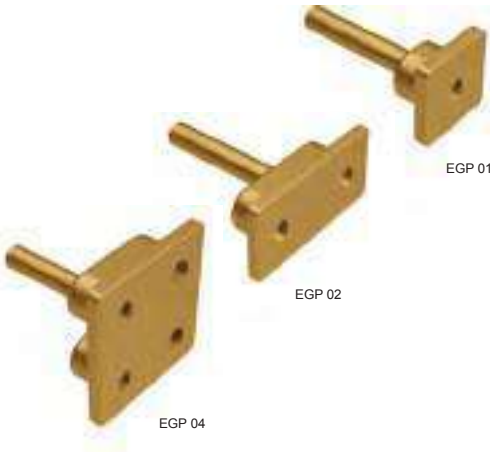
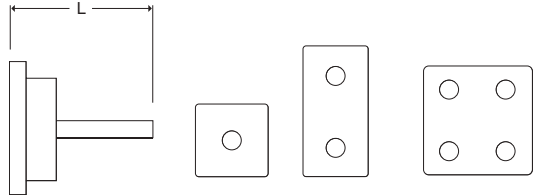

Earth Bonding Points with Pre-welded Tails

No. Holes	Type	Unit Weight kg	Pack Quantity	Part Number
1	EGP 01 with pre-welded 500mm long tail of 70mm ² PVC insulated cable	0.64	1	EGP 01 500
2	EGP 02 with pre-welded 500mm long tail of 70mm ² PVC insulated cable	0.77	1	EGP 02 500
	EGP 02 with pre-welded 1000mm long tail of 70mm ² PVC insulated cable	1.14		EGP 02 1000
	EGP 02 with pre-welded 1500mm long tail of 70mm ² PVC insulated cable	1.50		EGP 02 1500
4	EGP 04 with pre-welded 500mm long tail of 70mm ² PVC insulated cable	1.02	1	EGP 04 500
	EGP 04 with pre-welded 1000mm long tail of 70mm ² PVC insulated cable	1.39		EGP 04 1000
	EGP 04 with pre-welded 1500mm long tail of 70mm ² PVC insulated cable	1.75		EGP 04 1500

Material: High Copper Alloy body with PVC insulated copper cable tail.



BS EN 62561-1 Class H



Tightening torque 20 Nm

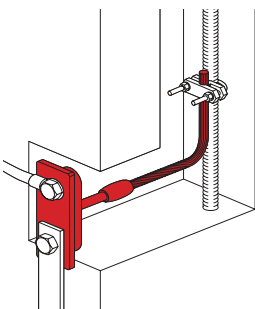
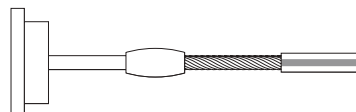

Earth Bonding Points with Double Pre-welded Tails

No. Holes	Type	Unit Weight kg	Pack Quantity	Part Number
1	EGP 01 with 2 x pre-welded 500mm long tails of 70mm ² PVC insulated cable	0.93	1	EGP 01 2
2	EGP 02 with 2 x pre-welded 500mm long tails of 70mm ² PVC insulated cable	1.08	1	EGP 02 2
	EGP 02 with 2 x pre-welded 1000mm long tails of 70mm ² PVC insulated cable	1.81		EGP 021 2
	EGP 02 with 2 x pre-welded 1500mm long tails of 70mm ² PVC insulated cable	2.54		EGP 025 2
4	EGP 04 with 2 x pre-welded 500mm long tails of 70mm ² PVC insulated cable	1.33	1	EGP 04 2
	EGP 04 with 2 x pre-welded 1000mm long tails of 70mm ² PVC insulated cable	2.06		EGP 041 2
	EGP 04 with 2 x pre-welded 1500mm long tails of 70mm ² PVC insulated cable	2.79		EGP 045 2



EGP 02 2

Material: High Copper Alloy body with 2 x PVC insulated copper cable tails.

Earth Bonding Points with a Front Plate

Suitable for 25x3mm tape or 70mm² cable.

No. Holes	Type	Unit Weight kg	Pack Quantity	Part Number
2	EGP 02 with a front plate	0.39	1	EGP 02P



EGP 02P

Material: High Copper Alloy.

Earth Bonding Points with a Pre-welded Tail & Front Plate

Suitable for 25x3mm tape or 70mm² cable.

No. Holes	Type	Unit Weight kg	Pack Quantity	Part Number
1	EGP 02 500 with a front plate	0.90	1	EGP 25P
2	EGP 02 1000 with a front plate	1.27		EGP 210P
	EGP 02 1500 with a front plate	1.63		EGP 215P



EGP 25P

Material: High Copper Alloy with PVC Insulated Copper Cable Tail.

Earth Bonding Points with 2 x Pre-welded Tails & Front Plate

Suitable for 25x3mm tape or 70mm² cable.

No. Holes	Type	Unit Weight kg	Pack Quantity	Part Number
	EGP 02 2 with a front plate	1.24	1	EGP 252P
2	EGP 021 2 with a front plate	1.97		EGP 2102P
	EGP 025 2 with a front plate	2.70		EGP 2152P



EGP 252P

Material: High Copper Alloy with 2 x PVC Insulated Copper Cable Tails.



EBC 006

Earth Bars

A. N. Wallis earth bars provide a convenient common earthing point for electrical installations. Our standard earth bars are manufactured from 50mm x 6mm hard drawn copper bar and come complete with M10 fittings and insulators. The PVC base makes our earth bars lighter and easier to handle as well as being entirely corrosion proof.

Special earth bars manufactured to customer requirements are also available.

Recommended fixing by countersunk wood screw 1 1/2" x No. 12 and No. 12 wall plug.

Earth Bars

No Terminations	L mm	W mm	H mm	Unit Weight kg	Pack Quantity	Part Number
2	200	90	60	1.00	1	EBC 002
3	250			EBC 003		
4	300			EBC 004		
6	400			EBC 006		
8	500			EBC 008		
9	600			EBC 009		
10	650			EBC 010		
12	750			EBC 012		
14	850			EBC 014		
16	950			EBC 016		
18	1100			EBC 018		
20	1250			EBC 020		
22	1300			EBC 022		
24	1400			EBC 024		
26	1550			EBC 026		
28	1650			EBC 028		
30	1800			EBC 030		

Material:

Bar: 50 x 6mm hard drawn copper bar to BS EN 13601.

Base: Plastic.

Fittings: M10 Hexagon Head Set Screws, Nuts & Washers..

Standard: BS 7430



BS EN 62561-1 Class H



Tightening torque 20 Nm

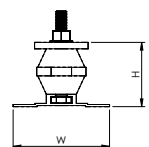
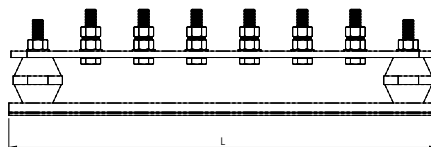
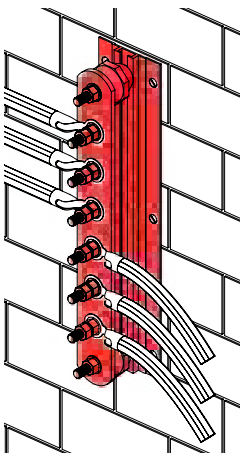

Tinned Earth Bars

The A. N. Wallis tinned earth bars have been used on a variety of high-profile projects, this is partly due to the fact that our tinned earth bars offer excellent resistance to water corrosion, and subsequently provide enhanced conductivity. The tinning process means that copper bars are protected from oxidation. Our tinned earth bars have a typical copper purity content in excess of 99.9%.

Special earth bars manufactured to customer requirements are also available.

Recommended fixing by countersunk wood screw 1 1/2" x No. 12 and No. 12 wall plug.



EBC 006T

Tinned Earth Bars

No Terminations	L mm	W mm	H mm	Unit Weight kg	Pack Quantity	Part Number
2	200	90	60	1.00	1	EBC 002T
3	250			1.22		EBC 003T
4	300			1.45		EBC 004T
6	400			2.00		EBC 006T
8	500			2.30		EBC 008T
9	600			2.75		EBC 009T
10	650			3.20		EBC 010T
12	750			4.00		EBC 012T
14	850			4.90		EBC 014T
16	950			5.80		EBC 016T
18	1100			6.70		EBC 018T
20	1250			7.60		EBC 020T
22	1300			8.50		EBC 022T
24	1400			9.40		EBC 024T
26	1550			10.30		EBC 026T
28	1650			11.20		EBC 028T
30	1800	12.10	EBC 030T			

Material:

Bar: 50 x 6mm tinned hard drawn copper bar to BS EN 13601

Base: Plastic.

Fittings: M10 Hexagon Head Set Screws, Nuts & Washers.

Standard: BS 7430

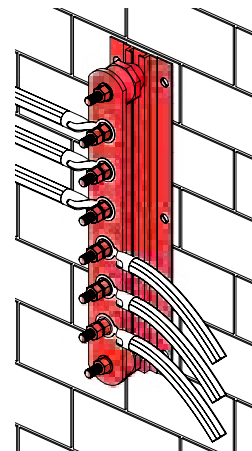
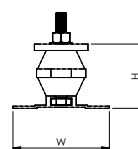
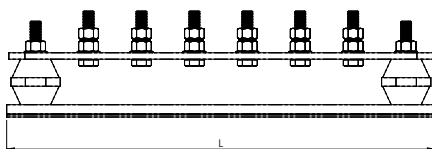



EBC 106

Earth Bars with Single Disconnecting Link

A. N. Wallis earth bars provide a convenient common earthing point for electrical installations. Our standard earth bars are manufactured from 50mm x 6mm hard drawn copper bar and come complete with M10 fittings and insulators. The PVC base makes our earth bars lighter and easier to handle as well as being entirely corrosion proof. All earth bars have a typical copper purity content in excess of 99.9%.

The A. N. Wallis single disconnecting link earth bars are mainly used to offer a temporary break in the connection to the earth, allowing the inspection and testing of multiple earth rods / systems while disconnected from the lightning and earth system.

Special earth bars manufactured to customer requirements are also available.

Recommended fixing by countersunk wood screw 1 1/2" x No. 12 and No. 12 wall plug.

Earth Bars with Single Disconnecting Link

No Terminations	L mm	W mm	H mm	Unit Weight kg	Pack Quantity	Part Number
2	285	90	60	1.55	1	EBC 102
3	330			EBC 103		
4	375			EBC 104		
6	475			EBC 106		
8	575			EBC 108		
9	685			EBC 109		
10	725			EBC 110		
12	825			EBC 112		
14	925			EBC 114		
16	1025			EBC 116		
18	1175			EBC 118		
20	1325			EBC 120		
22	1375			EBC 122		
24	1475			EBC 124		
26	1625			EBC 126		
28	1725			EBC 128		
30	1875	EBC 130				

Material:

Bar: 50 x 6mm hard drawn copper bar to BS EN 13601.

Base: Plastic.

Fittings: M10 Hexagon Head Set Screws, Nuts & Washers.

Standard: BS 7430



BS EN 62561-1 Class H



Tightening torque 20 Nm

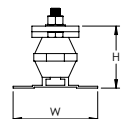
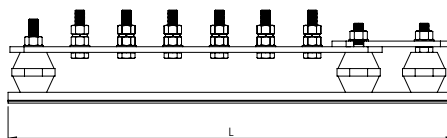
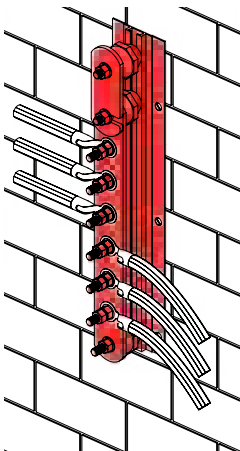

Tinned Earth Bars with Single Disconnecting Link

The A. N. Wallis tinned earth bars have been used on a variety of high-profile projects, this is partly due to the fact that our tinned earth bars offer excellent resistance to water corrosion, and subsequently provide enhanced conductivity. The tinning process means that copper bars are protected from oxidation. Our tinned earth bars have a typical copper purity content in excess of 99.9%.

The A. N. Wallis single disconnecting link tinned earth bars are mainly used to offer a temporary break in the connection to the earth, allowing the inspection and testing of multiple earth rods / systems while disconnected from the lightning and earth system.

Special earth bars manufactured to customer requirements are also available.

Recommended fixing by countersunk wood screw 1 1/2" x No. 12 and No. 12 wall plug.

Tinned Earth Bars with Single Disconnecting Link



EBC 106T

No Terminations	L mm	W mm	H mm	Unit Weight kg	Pack Quantity	Part Number
2	285	90	60	1.55	1	EBC 102T
3	330			EBC 103T		
4	375			EBC 104T		
6	475			EBC 106T		
8	575			EBC 108T		
9	685			EBC 109T		
10	725			EBC 110T		
12	825			EBC 112T		
14	925			EBC 114T		
16	1025			EBC 116T		
18	1175			EBC 118T		
20	1325			EBC 120T		
22	1375			EBC 122T		
24	1475			EBC 124T		
26	1625			EBC 126T		
28	1725			EBC 128T		
30	1875	EBC 130T				

Material:

Bar: 50 x 6mm tinned hard drawn copper bar to BS EN 13601.

Base: Plastic.

Fittings: M10 Hexagon Head Set Screws, Nuts & Washers.

Standard: BS 7430

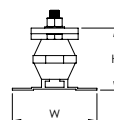
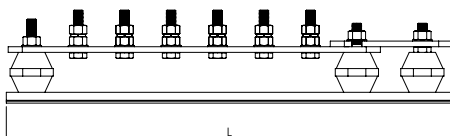
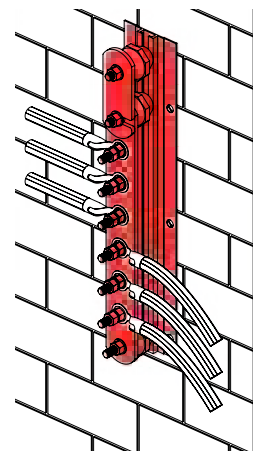



Earth Bars with Double Disconnecting Links

A. N. Wallis earth bars provide a convenient common earthing point for electrical installations. Our standard earth bars are manufactured from 50mm x 6mm hard drawn copper bar and come complete with M10 fittings and insulators. The PVC base makes our earth bars lighter and easier to handle as well as being entirely corrosion proof. All earth bars have a typical copper purity content in excess of 99.9%.

The A. N. Wallis double disconnecting link earth bars are mainly used to offer a temporary break in the connection to the earth, allowing the inspection and testing of multiple earth rods / systems while disconnected from the lightning and earth system.

Special earth bars manufactured to customer requirements are also available.

Recommended fixing by countersunk wood screw 1 1/2" x No. 12 and No. 12 wall plug.

Earth Bars with Double Disconnecting Links

No Terminations	L mm	W mm	H mm	Unit Weight kg	Pack Quantity	Part Number
2	350	90	60	2.10	1	EBC 202
3	400			EBC 203		
4	450			EBC 204		
6	550			EBC 206		
8	650			EBC 208		
9	725			EBC 209		
10	800			EBC 210		
12	900			EBC 212		
14	1000			EBC 214		
16	1100			EBC 216		
18	1250			EBC 218		
20	1400			EBC 220		
22	1450			EBC 222		
24	1550			EBC 224		
26	1700			EBC 226		
28	1800			EBC 228		
30	1950			EBC 230		

Material:

Bar: 50 x 6mm hard drawn copper bar to BS EN 13601.

Base: Plastic.

Fittings: M10 Hexagon Head Set Screws, Nuts & Washers.

Standard: BS 7430



BS EN 62561-1 Class H



Tightening torque 20 Nm

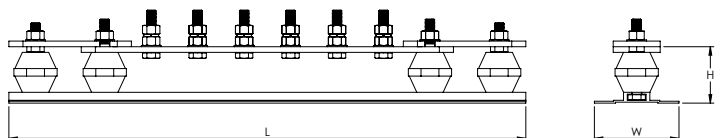
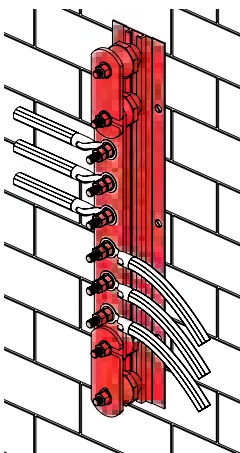

Tinned Earth Bars with Double Disconnecting Links

The A. N. Wallis tinned earth bars are used for a variety of high-profile projects, this is partly due to the fact that our tinned earth bars offer excellent resistance to water corrosion, and subsequently provide enhanced conductivity. The tinning process means that copper bars are protected from oxidation. Our tinned earth bars have a typical copper purity content in excess of 99.9%.

The A. N. Wallis double disconnecting link tinned earth bars are mainly used to offer a temporary break in the connection to the earth, allowing the inspection and testing of multiple earth rods / systems while disconnected from the lightning and earth system.

Special earth bars manufactured to customer requirements are also available.

Recommended fixing by countersunk wood screw 1 1/2" x No. 12 and No. 12 wall plug.

Tinned Earth Bars with Double Disconnecting Link

No Terminations	L mm	W mm	H mm	Unit Weight kg	Pack Quantity	Part Number
2	350	90	60	2.10	1	EBC 202T
3	400			2.32		EBC 203T
4	450			2.55		EBC 204T
6	550			3.10		EBC 206T
8	650			3.70		EBC 208T
9	725			4.10		EBC 209T
10	800			4.50		EBC 210T
12	900			5.30		EBC 212T
14	1000			6.20		EBC 214T
16	1100			7.10		EBC 216T
18	1250			8.00		EBC 218T
20	1400			8.90		EBC 220T
22	1450			10.50		EBC 222T
24	1550			10.70		EBC 224T
26	1700			11.60		EBC 226T
28	1800			12.50		EBC 228T
30	1950			13.40		EBC 230T

Material:

Bar: 50 x 6mm tinned hard drawn copper bar to BS EN 13601.

Base: Plastic.

Fittings: M10 Hexagon Head Set Screws, Nuts & Washers.

Standard: BS 7430

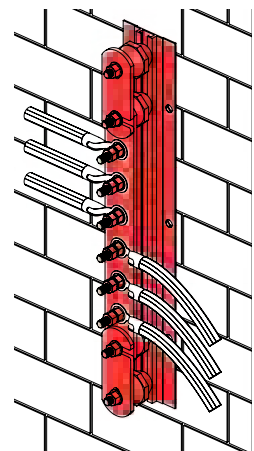
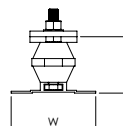
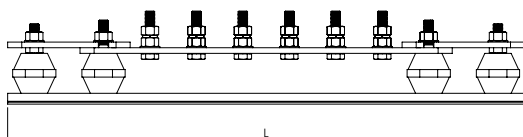



EBC 100

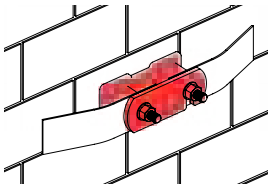

Disconnecting Link

The disconnecting link provides a temporary break in the earth connection to allow inspection and testing of the earth electrode.

L mm	W mm	H mm	Unit Weight kg	Pack Quantity	Part Number
120	45	45	0.60	1	EBC 100

Material:

Bar: 50 x 6mm hard drawn copper bar to BS EN 13601.

Base: Plastic.



BS EN 62561-1 Class H



Tightening torque 20 Nm

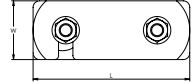
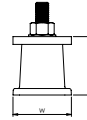
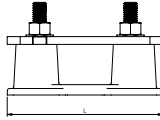

Double Row Telecommunication Earth Bars

The A. N. Wallis double row telecommunication earth bars provide a common grounding point within a telecommunications room and are usually located on the wall of a data room. These earth bars are available with different hole pattern spacing's, depending on your requirement and are made of high conductivity copper and can be tin-plated to help prevent against corrosion. The earth bars will also come pre-assembled with brackets and insulators for quick and easy installation.

Telecommunications Main Grounding Earth Bar

This item is used as a central consolidation point for telecommunications and other low voltage systems within the room. Typically located on walls or entry rooms where the exterior ground enters the building.

The EBCT12K & EBCT20K includes:

- 1 - Grounding bar assembly.
- 6 - #6 compression lugs.
- 1 each - #2, 1/0, 2/0, 3/0 compression lugs.
- 12 each - 1/4"-20 x 3/4" (19.0mm) SS4 hex bolts, hex nuts & lock washers.
- 6 each - 3/8"-16 x 1" (25.4mm) SS4 hex bolts, hex nuts & lock washers.



Earth Bars

L mm	L1 mm	W mm	Unit Weight kg	Pack Quantity	Part Number
305	229	102	2.13	1	EBCT12
305	229	102	3.49		EBCT12K
508	229	102	3.22		EBCT20
508	229	102	4.58		EBCT20K

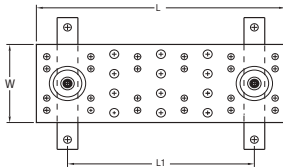

Telecommunications Grounding Earth Bar

This item provides a common grounding point within the telecommunications room. Typically located on walls within a data room.

The EBCGBK includes:

- 1 - Grounding bar assembly
- 6 - #6 compression lugs
- 1 each - #2, 1/0, 2/0, 3/0 compression lugs
- 12 each - 1/4"-20 x 3/4" (19.0mm) SS4 hex bolts, hex nuts & lock washers
- 6 each - 3/8"-16 x 1" (25.4mm) SS4 hex bolts, hex nuts & lock washers



Earth Bars

L mm	L1 mm	W mm	Unit Weight kg	Pack Quantity	Part Number
305	229	51	1.32	1	EBCGB
305	229	51	2.23		EBCGBK

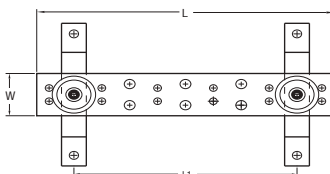

Special Earth Bars

Earth Bars are a vital part of any earthing system they provide a convenient common earthing point for electrical installations. In some cases our standard range of earth bars will not suit specific requirements, which is why we offer special earth bars.

If you provide a drawing we will provide you with the earth bar you need to meet your requirements.

A. N. Wallis earth bars are manufactured to last! To order or obtain a quote for a special earth bar, please contact our Sales Team on +44 (0) 115 927 1721 or alternatively email us info@an-wallis.com.

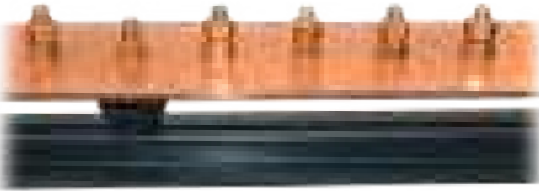

With many years of experience A. N. Wallis has designed and manufactured special earth bars based on customer/project requirements. We have manufactured many different styles of earth bars with different sizes and shapes over the years.

This bespoke service is tailored to your project specification and earthing needs. Any size of copper bar can be used, the number of disconnecting links can be altered as well as their position on the earth bar, fixing materials can be altered and we can supply earth bars with or without mounting bases to enable a product that is engineered to perfectly fit your exact requirements. All special earth bars can be tinned to help protect against adverse environmental conditions.

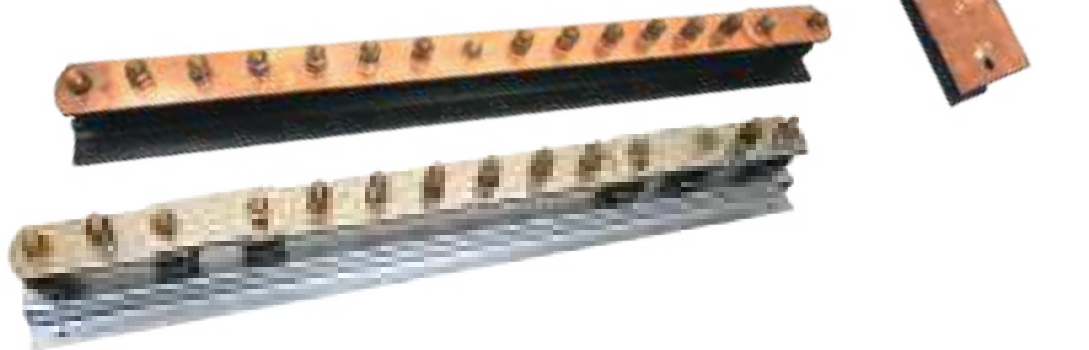

Insulators

These Wallis insulators are supplied with or without studs and locking nuts.

Type	Thread Size	W mm	H mm	Unit Weight kg	Pack Quantity	Part Number
Insulator	M10	40	40	0.08	10	EBI 001
	M10	40				EBI 003
	M6	18	20			EBI 009
	M6	32	30			EBI 011
	M8	38	40			EBI 012
	M10	46	50			EBI 013
	M10	50	60			EBI 014
	M12	55	70			EBI 015

Material: Reinforced Polyester.

Insulator with 2 studs and 3 nuts

Type	Thread Size	W mm	H mm	Unit Weight kg	Pack Quantity	Part Number
Insulator with 2 studs & 3 nuts	M10	40	40	0.16	10	EBI 002

Material: Reinforced Polyester with brass fittings.

The maximum working voltage of all A. N. Wallis insulators is 690V, these insulators can withstand a continuous temperature of 155-160°C or intermittent temperature of 220-225°C.

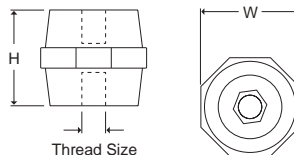

EBI 001

EBI 002

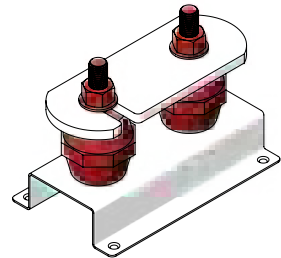

Earth Blocks

These Wallis blocks allow earth conductor termination, or live conductor termination with a suitable, fully insulated housing.

Type	L mm	W mm	H mm	Unit Weight kg	Pack Quantity	Part Number
4-Way Single	54	9	12	0.06	50	EBB 004/1
4-Way Double	51	18		0.09		EBB 004
8-Way Double	88	18		0.15		EBB 008

Material: Tinned Brass.

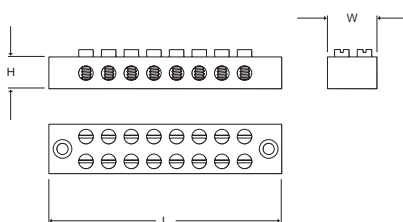

EBB 004

EBB 008

EBB 004/1

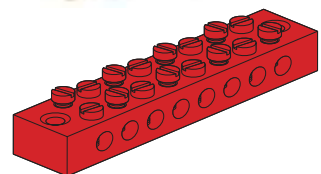

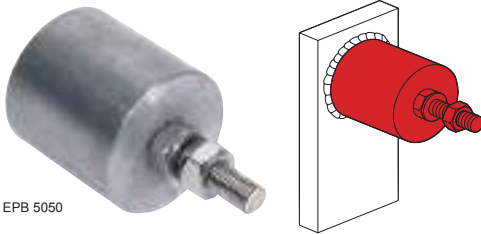

EPB 5050

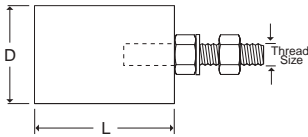

Earth Bosses

The earth boss is designed to provide an earth connection point on a steel structure. The boss is welded onto steel vessels, tanks and other structures. Wrap connections with Denso tape.

D mm	L mm	Thread Size	Unit Weight kg	Pack Quantity	Part Number
25	25	M8	0.11	1	EPB 2525
30	30	M8	0.18		EPB 3030
30	30	M10	0.20		EPB 3030/10
30	40	M10	0.33		EPB 3040
30	40	M12	0.36		EPB 3040/12
30	50	M10	0.50		EPB 3050
30	50	M12	0.52		EPB 3050/12
40	30	M8	0.24		EPB 4030/8
40	30	M10	0.35		EPB 4030
40	40	M10	0.43		EPB 4040
40	40	M12	0.45		EPB 4040/12
40	50	M10	0.65		EPB 4050
40	50	M12	0.67		EPB 4050/12
50	30	M8	0.29		EPB 5030/8
50	30	M10	0.31		EPB 5030
50	40	M10	0.53		EPB 5040
50	40	M12	0.55		EPB 5040/12
50	50	M10	0.80		EPB 5050
50	50	M12	0.80		EPB 5050/12

Material: Mild Steel with Stainless Steel fittings.

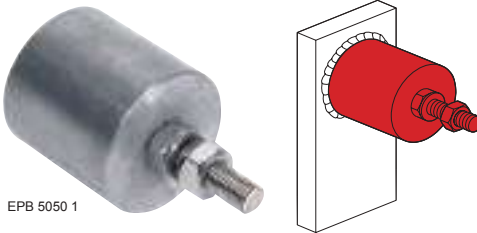

EPB 5050 1

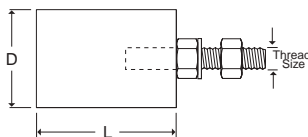

Stainless Steel Earth Bosses

The stainless steel earth boss is designed to provide an earth connection point on a stainless steel structure. The boss is welded onto stainless steel vessels, tanks and other stainless steel structures. Wrap connections with Denso tape.

D mm	L mm	Thread Size	Unit Weight kg	Pack Quantity	Part Number
25	25	M8	0.11	1	EPB 2525 S
30	30	M8	0.18		EPB 3030 S
30	30	M10	0.20		EPB 3030 1
30	40	M10	0.33		EPB 3040 1
30	40	M12	0.36		EPB 3040 2
30	50	M10	0.50		EPB 3050 1
30	50	M12	0.52		EPB 3050 2
40	30	M8	0.24		EPB 4030 S
40	30	M10	0.35		EPB 4030 1
40	40	M10	0.43		EPB 4040 1
40	40	M12	0.45		EPB 4040 2
40	50	M10	0.65		EPB 4050 1
40	50	M12	0.67		EPB 4050 2
50	30	M8	0.29		EPB 5030 S
50	30	M10	0.31		EPB 5030 1
50	40	M10	0.53		EPB 5040 1
50	40	M12	0.55		EPB 5040 2
50	50	M10	0.80		EPB 5050 1
50	50	M12	0.80		EPB 5050 2

Material: Stainless Steel body & Stainless Steel fittings

Split Bolt Connectors

The high strength split bolt connectors will accept a wide range of stranded copper conductors. No specialist tools are required for installation.

Main Conductor A mm ²	Tap Conductor B mm ²	H mm	W mm	Unit Weight kg	Pack Quantity	Part Number
10	1.5 - 10	20	4	0.02	200	SBC 010
16	2.5 - 16	23	5	0.03	150	SBC 016
25	2.5 - 25	28	7	0.04	100	SBC 025
35	2.5 - 35	29	8	0.05	80	SBC 035
50	2.5 - 50	35	10	0.08	50	SBC 050
70	2.5 - 70	39	11	0.12	35	SBC 070
95	2.5 - 95	45	14	0.15	20	SBC 095
120	10 - 120	47	15	0.18	20	SBC 120
150	10 - 150	51	16	0.23	10	SBC 150
185	50 - 185	57	18	0.35	10	SBC 185
240	95 - 240	64	19	0.46	10	SBC 240

Material: High Copper Alloy.

Standard: BS 7430

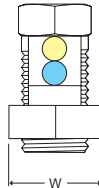
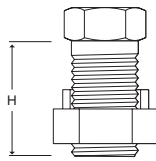
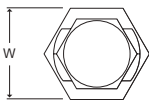

SBC 025



SBC 120

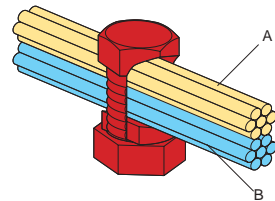

HV Surge Counter Coupling

The HV Surge counter coupling (SCC001) is used in conjunction with the Siemens Surge Counter to allow a convenient connection between the surge counter and the conductor it is being connected to.

This assembly is usually installed on High Voltage Substations as part of the High Frequency earthing arrangement. One assembly will be installed per phase at cable sealing ends and other parts of the system where HV surges to earth are to be monitored. This is to be installed generally in line with National Grid Specification TS 3.1.2.

D mm	L mm	Thread Size	Unit Weight kg	Pack Quantity	Part Number
40	125	M12	0.75	1	SCC 001

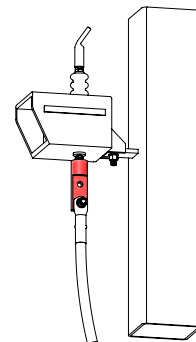
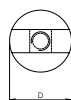
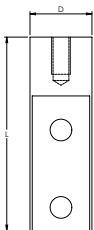

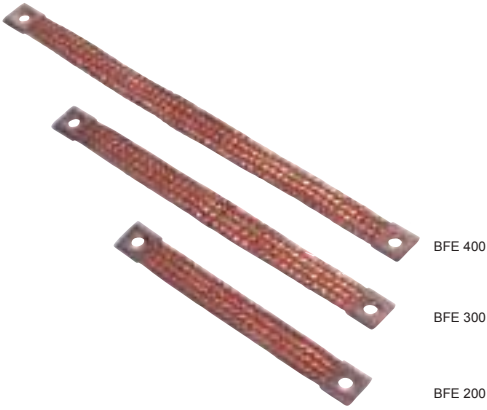

Flexible Copper Braid Bonds

These flexible copper braid bonds are used for bonding metal gates, doors, fences etc. Other lengths and sizes are available on request.

Size W x H mm	Hole Centres L mm	Hole Size mm	Unit Weight kg	Pack Quantity	Part Number
10 x 2	100	6	0.01	10	BFE 1021
	200		0.01		BFE 1022
	300		0.01		BFE 1023
12 x 2	100	6	0.01		BFE 121
	200		0.01		BFE 122
	300		0.02		BFE 123
19 x 2.5	100	10	0.01		BFE 191
	200		0.03		BFE 192
	300		0.05		BFE 193
25 x 3	100	10	0.02		BFE 2531
	200		0.05		BFE 2532
	400		0.10		BFE 2534
25 x 3.5	200	11	0.09	BFE 200	
	300		0.13	BFE 300	
	400		0.16	BFE 400	
30 x 4.5	200	10	0.10	BFE 302	
	400		0.20	BFE 304	
32 x 5	200	10	0.14	BFE 322	
	400		0.28	BFE 324	

Material: Copper.



BS EN 62561-1 Class H



Tightening torque 20 Nm

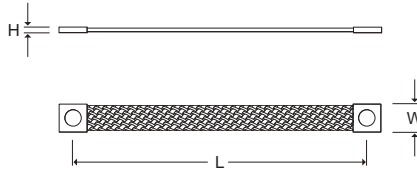
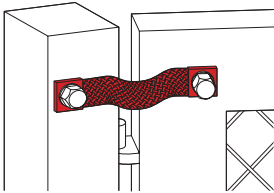

Tinned Flexible Copper Braid Bonds

These flexible copper braid bonds are used for bonding metal gates, doors, fences etc. Other lengths and sizes are available on request.

Size W x H mm	Hole Centres L mm	Hole Size mm	Unit Weight kg	Pack Quantity	Part Number
10 x 2	100	6	0.01	10	BFE 1021T
	200		0.01		BFE 1022T
	300		0.01		BFE 1023T
12 x 2	100		0.01		BFE 121T
	200		0.01		BFE 122T
	300		0.02		BFE 123T
19 x 2.5	100	10	0.01		BFE 191T
	200		0.03		BFE 192T
	300		0.05		BFE 193T
25 x 3	100		0.02		BFE 2531T
	200		0.05		BFE 2532T
	400		0.10		BFE 2534T
25 x 3.5	200	11	0.09	BFE 200T	
	300		0.13	BFE 300T	
	400		0.16	BFE 400T	
30 x 4.5	200	10	0.10	BFE 302T	
	400		0.20	BFE 304T	
32 x 5	200		0.14	BFE 322T	
	400		0.28	BFE 324T	

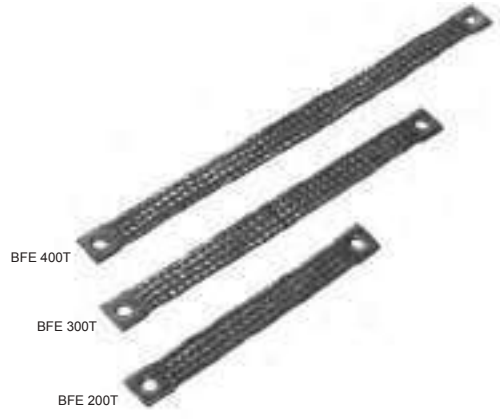

Material: Tinned Copper.

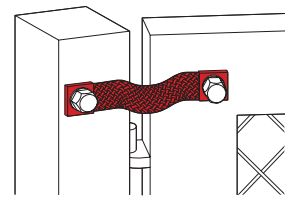
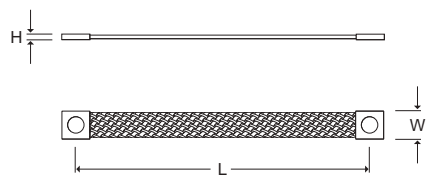



Flexible Circular Copper Braid Bonds

These flexible circular copper braid bonds are used for bonding metal gates, doors, fences etc. Other lengths and sizes are available on request.

Nominal Area mm ²	Hole Centres L mm	Hole Size mm	Unit Weight kg	Pack Quantity	Part Number
4	100	M6	0.01	10	BCE 410
	200		0.01		BCE 420
	300		0.01		BCE 430
6	100		0.01		BCE 610
	200		0.01		BCE 620
	300		0.02		BCE 630
10	100		0.01		BCE 101
	200		0.02		BCE 102
	300		0.03		BCE 103
16	100		0.01		BCE 1616
	200		0.03		BCE 1626
	300		0.05		BCE 1636
	100	0.01	BCE 161		
	200	0.03	BCE 162		
	300	0.05	BCE 163		
25	200	0.03	BCE 252		
	400	0.05	BCE 254		
35	200	M10	0.07	BCE 352	
	400		0.14	BCE 354	
50	200		0.10	BCE 502	
	400		0.20	BCE 504	
70	200		0.14	BCE 702	
	400		0.28	BCE 704	

Material: Copper.

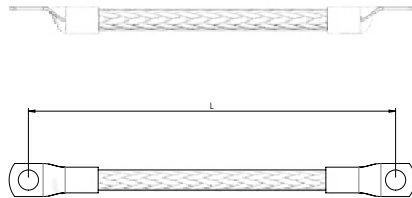
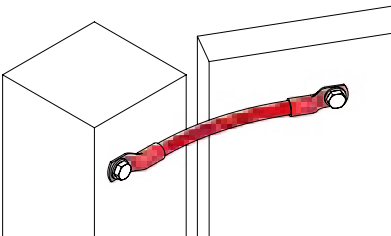

Tinned Flexible Circular Copper Braid Bonds

These tinned flexible copper braid bonds are used for bonding metal gates, doors, fences etc. Other lengths and sizes are available on request.

Nominal Area mm ²	Hole Centres L mm	Hole Size mm	Unit Weight kg	Pack Quantity	Part Number
4	100	M6	0.01	10	BCE 410T
	200		0.01		BCE 420T
	300		0.01		BCE 430T
6	100		0.01		BCE 610T
	200		0.01		BCE 620T
	300		0.02		BCE 630T
10	100		0.01		BCE 101T
	200		0.02		BCE 102T
	300		0.03		BCE 103T
16	100		0.01		BCE 1616T
	200		0.03		BCE 1626T
	300		0.05		BCE 1636T
	100	0.01	BCE 161T		
25	200	0.03	BCE 162T		
	300	0.05	BCE 163T		
	200	0.03	BCE 252T		
35	400	0.05	BCE 254T		
	200	0.07	BCE 352T		
50	400	0.14	BCE 354T		
	200	0.10	BCE 502T		
	400	0.20	BCE 504T		
70	200	0.14	BCE 702T		
	400	0.28	BCE 704T		

Material: Tinned Copper.

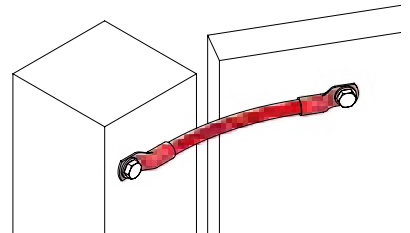
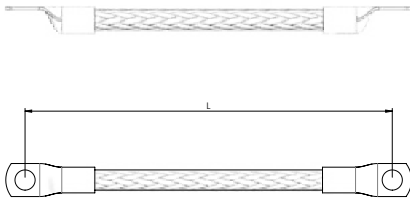

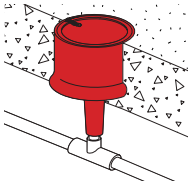

Static Earth Receptacle

This receptacle is used in open areas where a temporary earthing point may be required, such as airfields or petrol stations. Provides a static discharge point for aircraft, tankers, vehicles and boats.

H mm	D mm	Unit Weight kg	Pack Quantity	Part Number
135	125	3.00	1	ERX 05

Material: High Copper Alloy

Standard: BS 7430

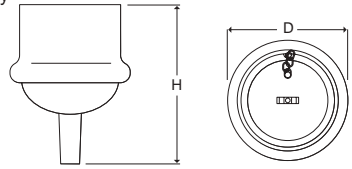

Eyebolts

Provides a static earth point when attached to the top of a threaded copperbond earth rod.

Thread Size	H mm	Unit Weight kg	Pack Quantity	Part Number
5/8"	135	0.62	1	EYE 058
3/4"		0.55		EYE 034

Material: High Copper Alloy.

Standard: BS 7430

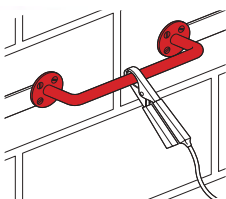
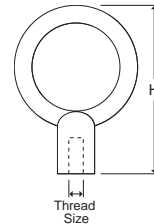

Static Earth Bar

This wall-mounted bracket provides a temporary earth point.

L mm	H mm	Unit Weight kg	Pack Quantity	Part Number
350	100	1.52	1	ERY 10
200	250			ERY 20

Material: Phosphor Bronze.

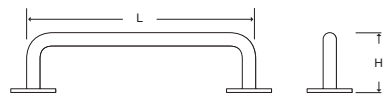

'C' Crimp Connectors

These range-taking 'C' Crimp Connectors are specifically designed for tap and parallel connections of stranded copper cables in earthing applications.

Main Conductor A mm ²	Tap Conductor B mm ²	L mm	W mm	H mm	Unit Weight kg	Pack Quantity	Part Number
10	4 - 10	13	12	9	0.01	100	CCC 010
10 - 16	10 - 16	19	17	12	0.01	100	CCC 016
16	4	19	17	12	0.01	100	CCC 016
16 - 25	1.5 - 10	20	12	13	0.02	100	CCC 25-10
25	10 - 16	21	19	12	0.02	50	CCC 25PM
25	10 - 25	24	20	15	0.04	50	CCC 025
35	1.5 - 16	24	20	15	0.04	50	CCC 025
35	25 - 35	27	20	15	0.05	50	CCC 035
50	4 - 16	27	20	15	0.05	50	CCC 035
50	16 - 50	27	20	17	0.07	50	CCC 050
70	1.5 - 25	27	20	17	0.07	25	CCC 050
50 - 70	4 - 35	33	28	21	0.09	25	CCC 70-35
50 - 70	35 - 70	34	28	21	0.10	25	CCC 070
70 - 95	35 - 70	41	30	26	0.10	25	CCC 075
95	4 - 35	41	30	26	0.11	25	CCC 95-35
70 - 95	95	41	30	26	0.12	25	CCC 095
120	35 - 120	45	30	28	0.12	25	CCC 120
150	6 - 70	45	30	28	0.12	25	CCC 120
150	95 - 150	45	30	28	0.15	10	CCC 150
120 - 185	95 - 185	54	35	33	0.20	10	CCC 185
150 - 185	70 - 150	54	35	33	0.20	10	CCC 185
							CCC 240-35
							CCC 240-50
240	10 - 70	54	35	34	0.25	10	CCC 240-70
240	95 - 120	54	37	34	0.24	10	CCC 240-120
240	150 - 240	54	40	43	0.24	10	CCC 240

Material: Copper.

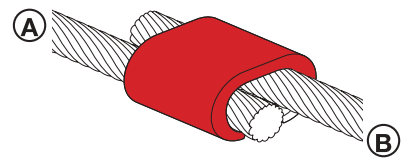
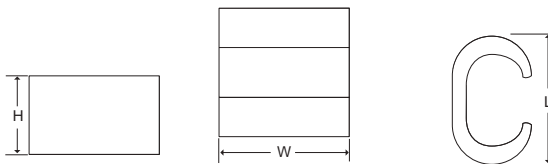

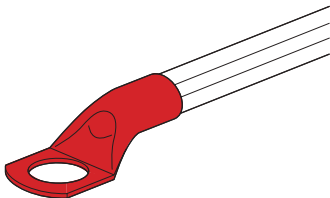
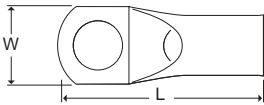

Compression Terminals

Wallis cable terminals are manufactured from high-conductivity seamless copper tube and feature bell mouth entry for cables up to 500mm² and chamfered entry for cables 500mm² to 1000mm².

All terminals are annealed, to avoid cracking and splitting when crimped, and electro-tin plated to combine maximum electrical conductivity with mechanical strength. An inspection hole is provided to facilitate the insertion of the cable conductor, these should only be used as a dry indoor cable termination when installed using a suitably calibrated crimping tool and die set.

Conductor Size mm ²	Palm Hole Size mm	L mm	W mm	Unit Weight kg	Pack Quantity	Part Number
6	4	21	9	0.01	100	CLG 64
	5	24	10			CLG 65
	6	24	11			CLG 66
	8	25	12			CLG 68
	10	26	12			CLG 610
10	5	26	11	0.01	100	CLG 105
	6	26	11			CLG 106
	8	29	13			CLG 108
	10	39	16			CLG 1010
	12	39	18			CLG 1012
16	6	30	11	0.01	100	CLG 166
	8	30	13			CLG 168
	10	35	15			CLG 1610
	12	42	18			CLG 1612
25	6	32	14	0.01	50	CLG 256
	8	32	14			CLG 258
	10	38	16			CLG 2510
	12	38	18			CLG 2512
35	6	35	15	0.01	50	CLG 356
	8	35	15			CLG 358
	10	40	15			CLG 3510
	12	40	18			CLG 3512
	14	43	20			CLG 3514
50	6	37	17	0.02	50	CLG 506
	8	37	17			CLG 508
	10	42	17			CLG 5010
	12	42	17			CLG 5012
	14	45	20			CLG 5014
70	6	40	21	0.04	50	CLG 706
	8	40	21			CLG 708
	10	46	21			CLG 7010
	12	46	21			CLG 7012
	14	50	21			CLG 7014
	16	50	21			CLG 7016

Table continues on P73

Compression Terminals (continued)

Conductor Size mm ²	Palm Hole Size mm	L mm	W mm	Unit Weight kg	Pack Quantity	Part Number
95	6	47	25	0.06	25	CLG 956
	8	49	25			CLG 958
	10	49	25			CLG 9510
	12	49	25			CLG 9512
	14	56	25			CLG 9514
120	16	56	25	CLG 9516	0.07	25
	8	50	27	CLG 1208		
	10	56	27	CLG 12010		
	12	56	27	CLG 12012		
	14	56	27	CLG 12014		
150	16	60	27	CLG 12016	0.09	25
	20	66	27	CLG 12020		
	8	66	30	CLG 1508		
	10	68	30	CLG 15010		
	12	68	30	CLG 15012		
185	14	68	30	CLG 15014	0.10	10
	16	70	30	CLG 15016		
	20	75	30	CLG 15020		
	10	67	33	CLG 18510		
	12	68	33	CLG 18512		
240	14	68	33	CLG 18514	0.14	10
	16	70	33	CLG 18516		
	20	75	33	CLG 18520		
	10	88	38	CLG 24010		
	12	88	38	CLG 24012		
300	14	88	38	CLG 24014	0.17	10
	16	88	38	CLG 24016		
	20	88	38	CLG 24020		
	10	97	41	CLG 30010		
	12	97	41	CLG 30012		
400	14	97	41	CLG 30014	0.20	10
	16	97	41	CLG 30016		
	20	97	41	CLG 30020		
	12	108	47	CLG 40012		
	14	108	47	CLG 40014		
500	16	108	47	CLG 40016	0.50	5
	20	108	47	CLG 40020		
	16	117	53	CLG 50016		
630	18	117	53	CLG 50018	0.80	5
	20	117	53	CLG 50020		
	16	127	63	CLG 63016		
800	18	127	63	CLG 63018	1.00	5
	20	127	63	CLG 63020		
	16	164	70	CLG 80016		
1000	18	164	70	CLG 80018	1.30	5
	20	164	70	CLG 80020		
	18	164	77	CLG 100018		
	20	164	77	CLG 100020		



CLG 1208



CLG 15012



CLG 24014



CLG 30016

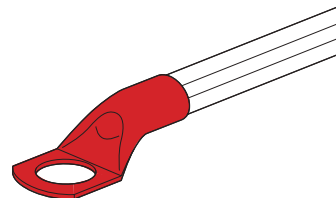
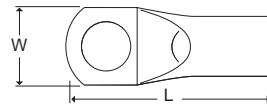

Material: Tin Plated Copper.

Copyright : This brochure is Copyrighted to A N. Wallis & Co. Ltd. Unauthorised reproduction or storage without permission is an infringement of that Copyright. Infringement of Copyright will result in legal actions. January 2019.

Product Development: It is A N. Wallis's policy to continuously improve its products . Accordingly, A N. Wallis reserves the right to amend product descriptions, specifications and performance without prior notice.



A. N. WALLIS & Co. Ltd • Greasley Street • Bullwell, Nottingham • East Midlands • NG6 8NG • United Kingdom
Tel +44 (0) 115 927 1721 • Fax +44 (0)115 875 6630 • E-mail info@an-wallis.com • Website www.an-wallis.com

CATWPC 01/19



FM73972 OHS 654406